

9220 TOC Analyzer

TOTAL ORGANIC CARBON ONLINE ANALYZER





General Information

The information contained in this manual is subject to change without notice.

Effort has been made to make the information in this manual complete, accurate, and current.

The manufacturer shall not be held responsible for errors or omissions in this manual, or for incidental or consequential damages in connection with the furnishing, performance, or use of this material.

No part of this document may be reproduced, photocopied, or translated to another language without the prior written consent of YSI.

Consult YSI.com for the most up-to-date version of this manual.

Limited Warranty

Xylem warrants each Xylem manufactured product against defects in materials and workmanship under normal use and service for a period of two years. Equipment installed by Xylem is warranted from the installation date; all other equipment is warranted from the ship date. If purchaser schedules or delays installation more than 90 days after delivery, then the warranty period starts on the 91st day from date of shipment. This warranty extends only to the original purchaser. Xylem will, at its option, repair or replace equipment that proves to be defective during the warranty period, provided the equipment is returned to Xylem at the expense of the purchaser.

Consumables, expendables, and parts are warranted for 30 days and are not covered under extended warranties or service contracts.

Xylem warrants for a period of two years from the date of delivery: (i) the software, when installed and used with a Xylem-recommended hardware configuration, will perform in substantial conformance with the documentation supplied with the software; and (ii) the physical media on which the software is furnished will be free from defects in materials and workmanship under normal use.

This warranty shall not apply to defects originating from, but not limited to, the following:

- Improper maintenance or operation by the purchaser;
- Purchaser-supplied accessories or consumables;
- Modification or misuse by the purchaser;
- Operation outside the product's environmental and electrical specifications;
- Software, interfacing, parts, or supplies not supplied by Xylem;
- Improper or inadequate site preparation;
- Purchaser-induced contamination or leaks.

THE FOREGOING WARRANTY IS IN LIEU OF ALL OTHER WARRANTIES, EXPRESSED OR IMPLIED, INCLUDING BUT NOT LIMITED TO ANY WARRANTY OF MERCHANTABILITY, FITNESS, OR ADEQUACY FOR ANY PARTICULAR PURPOSE OR USE. YSI SHALL NOT BE LIABLE FOR ANY SPECIAL, INCIDENTAL, OR CONSEQUENTIAL DAMAGES, WHETHER IN CONTRACT, TORT, OR OTHERWISE.

Any service requests or questions should be directed to the YSI Customer Support Center at (937) 767-7241.

Table of Contents

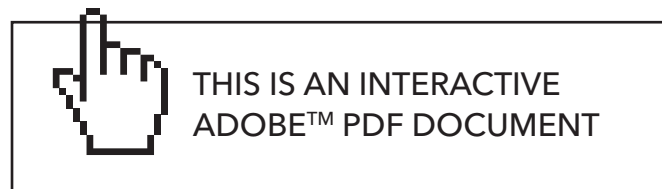

1. General Product Information	3	6. Maintenance	88
1.1 Instrument Description.....	3	6.1 General System Maintenance.....	88
1.2 Operating Principle.....	3	6.2 Routine Inspections.....	88
1.3 General Features.....	3	6.3 Additional Maintenance.....	89
1.4 Patent Disclosure.....	3	6.4 Syringe Plunger Inspection/Replacement.....	90
1.5 Instrument Specifications.....	4	6.5 Tubing & Fitting Inspection/Replacement.....	90
1.6 Safety Information.....	5	6.6 Check Valve Inspection/Replacement.....	90
2. Instrument Components	8	6.7 Data Archiving.....	90
2.1 Front View (and Mounting Dimensions).....	8	7. Troubleshooting	91
2.2 Left Side View.....	9	7.1 Basic Troubleshooting.....	91
2.3 Right Side View.....	10	7.2 Plumbing Diagram.....	96
2.4 Rear View (and Mounting Dimensions).....	11	8. Equipment Options	97
2.5 Bottom View.....	12	9. Replacement Parts	99
2.6 Electronics Compartment (Outside).....	13	10. Method Development	103
2.7 Electronics Compartment (Inside).....	14	10.1 Method Development Variables.....	103
2.8 Analytical Compartment.....	16	10.2 Method Verification Techniques.....	107
3. Installation	18	11. System Calculations	108
3.1 Site Preparation/User-Supplied Materials.....	18	11.1 Instrument Calibration: Linear Regression.....	108
3.2 Hardware Installation.....	19	11.2 9220 Calibration Calculations.....	108
3.3 Installing the Mounting Panel & 9220 TOC.....	20	12. Appendix A	
4. User Interface	28	Phosphoric Acid Reagent Preparation.....	111
4.1 Logging into the 9220 Software.....	28	13. Declaration of Conformity	112
4.2 User Interface Layout.....	28		
4.3 Monitor Screen.....	31		
4.4 Data Screen.....	36		
4.5 Configuration Screen.....	40		
4.6 Maintenance Screen.....	56		
4.7 Alarm Screen.....	72		
5. 9220 Operation	73		
5.1 Introduction.....	73		
5.2 Basic Overview of Components.....	73		
5.3 Configure the 9220 System.....	73		
5.4 Calibrate the 9220 System.....	79		
5.5 Validate the 9220 Calibration.....	80		
5.6 Define a Continuous Sampling Sequence.....	81		
5.7 Start the Continuous Sequence.....	81		
5.8 Monitor the 9220 Operations.....	83		
5.9 Monitor & Manage Sample Results Data.....	84		

1. General Product Information

1.1 Instrument Description

The **9220 Online Total Organic Carbon (TOC) Analyzer** is designed to continuously monitor TOC levels in process water streams. The 9220 uses proven heated persulfate oxidation technology for accurate, dependable operation and regulatory compliance. Virtually all organic compounds dissolved in water can be oxidized with high efficiency by this technique.

The 9220 Online TOC Analyzer is specifically engineered for operation in process environments. The instrument can be wall or rack-mounted in indoor or shade-sheltered outdoor locations.

1.2 Operating Principle

The 9220 Online TOC Analyzer employs the heated sodium persulfate ($\text{Na}_2\text{S}_2\text{O}_8$) oxidation technique to determine the total organic carbon level in process water samples. In operation, samples are drawn into the 9220 at 4- to 9-minute intervals from a fill-and-spill sampling system. Phosphoric acid is introduced into the syringe to sparge and remove the inorganic (TIC) content. The TIC-free sample is then transferred into the reaction chamber and oxidized at a programmed temperature of up to 98 °C.

Organic compounds are oxidized and converted to CO_2 which is measured by a solid-state non-dispersive infrared (SSNDIR) detector to calculate the TOC content. Results for each sample are shown on the touchscreen display and can be output to a Supervisory Control and Data Acquisition (SCADA) system, relay/alarm closure, or as a 4-20mA analog signal.

1.3 General Features

The 9220 offers these basic design features:

- Heated sodium persulfate oxidation technique
- Near-real-time monitoring and warning of organic contamination
- Data export to SCADA system via RS-485 or as 4-20mA analog signals
- Output relays (2) for system or sample alarms
- Remote start/stop capability
- Automatic calibration/validation
- Internally generated CO_2 -free air for sparging and detection

1.4 Patent Disclosure

The 9220 is protected by the following Patents:

- U.S. Patent - Solid State Non-Dispersive Infrared Detector (SSNDIR)



1.5 Instrument Specifications

Performance	
Operating Principle	Heated sodium persulfate oxidation
Measurement Technique	Non-dispersive infrared (NDIR) detection
Regulatory Method Compliance	USEPA 415.3 (source water & drinking water); SM 5310C (water & wastewater)
Measurement Range	0 to 25 ppm (standard); adjustable up to 100 ppm
Measurement Accuracy	±5%
Measurement Precision	2% RSD
Limit of Detection	0.015 ppm
Sample Processing/Analysis Time	5 to 9 minute intervals
Sample Processing Ports	6 (included)
Sample Processing Valve Controls	4 (included)
Sample Processing Valves	Up to 4 (optional)
General	
Operator Interface	7" WSVGA display with a capacitive touchscreen (Windows® CE-based)
External Dimensions (Enclosure)	58.5cm H x 55.9cm W x 25.4cm D (23in H x 22in W x 10in D)
Mounting Dimensions (Panel w/ reagent tray)	113.7cm H x 55.9cm W x 28cm D (44.75in H x 22in x 11in D)
Certifications	See Declaration of Conformity (Page 112)
Instrument Enclosure Certifications	IP66; NEMA 4
Weight	Analyzer: 16.6 kg (36.5 lbs); Analyzer, panel w/ reagent tray, PGM, and full reagent containers: 44.4 kg (98 lbs)
Instrument Warranty	2 years
Reagents and Requirements	
Reagents Required	10% sodium persulfate, 5% phosphoric acid, DI water
Reagent Containers	5L high-density polyurethane
Reagent Lifetime (Liquid)	Nominally 30 days at 77 °F (25 °C); 90 days at temperatures < 39 °F (4 °C)
Sample and Gas Requirements	
Sample Flow Rate to Sample Inlet Device	50 to 1,000 mL/min when using Sample Inlet Device
Inlet Pressure	1 to 20 psig with Sample Inlet Device
Sample Temperature Range	41 to 113 °F (5 to 45 °C)
Gas Requirements (internally generated)	Process Gas Module (included); Consumption = < 100 ml/min. CO ₂ free air
Power and Communication	
Power Requirements	100 to 240 VAC, 150VA, 50/60 Hz Fluctuation: +/- 10% max; Over-voltage: Category II
Input Relays	2 (remote start, remote stop); 5A/30 VDC Max - potential free contact closure
Output Relays	2 (system alarm, sample alarm); 5A/30 VDC Max - potential free contact closure
Analog Outputs	4 (4 to 20 mA; user-configurable concentrations)
Digital Outputs	RS-485/422 Modbus RTU protocol or ASCII standard
Data Export	To PC via USB memory stick (Microsoft® Excel®-ready .csv file format)
Environmental	
Operating Temperature Range	41 to 113 °F (5 to 45 °C)
Humidity	Up to 90% humidity (non-condensing)
Storage Temperature Range	41 to 113 °F (5 to 45 °C)
Relative Humidity	90% at 40°C non-condensing
Pollution Degree	PD2
Altitude (Max Operating)	3000m (10,000 ft)

1.6 Safety Information

The 9220 Online Total Organic Carbon Analyzer was designed in accordance with the following safety and emissions standards.

- See Declaration of Conformity (Page 112)

Using the instrument in a manner not specified by the manufacturer may impair the instrument's safety protection. Whenever the safety protection of the 9220 TOC analyzer is compromised, disconnect the instrument from all power sources and secure the instrument against unintended operation.

The exposure to personal hazards for the 9220 TOC analyzer in all usage conditions and locations has not been precisely defined. The instructions for installation and operation given in this manual are believed to be a thorough account for proper and safe operation. However, it is the responsibility of each facility to maintain the 9220 TOC analyzer in a condition suitable for safe use.

Operator Precautions

Please read this entire manual before unpacking, installing and operating this instrument. Ensure that the protection provided by the instrument is not impaired. Do not install or use this instrument in any manner other than that specified in this manual. For operator safety, pay attention to **DANGER**, **WARNING** and **CAUTION** statements throughout the manual.



WARNING indicates a condition or possible situation that could result in physical injury to the operator.



CAUTION indicates a condition or possible situation that could damage or destroy the product or the operator's work.

NOTE: Information that is supplemental to the point in the main text.

Follow warnings and precautions in this manual or on the instrument during operation, service and repair. Failure to follow these warnings and precautions violates the safety design standards and intended use of the instrument. Xylem is not liable for the operator's failure to comply with these warnings and precautions.

Precautionary Labels

Please read all labels and tags attached to the instrument. Personal injury or damage to the instrument could occur if not observed.



Electrical equipment marked with this symbol may not be disposed of in the European public disposal systems after 12 August 2005. In conformity with European local and national regulations (EU Directive 2002/96/EC), European electrical equipment users must now return old or end-of-life equipment to the Producer for disposal at no charge to the user.

NOTE: For return for recycling, please contact the equipment producer or supplier for instructions on how to return end-of-life equipment, producer-supplied electrical accessories, and all auxiliary items for proper disposal.

General Precautions



WARNING Any interruption of the grounding conductor or disconnecting the protective earth terminal could cause a shock that could result in personal injury.

- Ensure the power to the instrument is turned off and the instrument's inlet power cable is disconnected before removing covers.
- Replace or repair faulty or frayed insulation on power cords.
- Perform periodic leak checks on supply lines, fittings, and pneumatic plumbing.
- Arrange gas lines so they cannot become kinked, punctured, or otherwise damaged, and will not interfere with foot traffic.
- Turn off the power and disconnect the instrument's inlet power cord before using a liquid solution to locate leaks.
- Wear safety glasses to prevent possible eye injury.
- Do not perform unauthorized modifications or substitute parts that are not Xylem original parts to the instrument. Any unauthorized modifications or substitutions will void the warranty.

Chemical Precautions

- The toxicity or potential health risk hazard of chemicals used in this technique are defined by the SDS that accompanies the chemicals. However, treat all chemicals and samples used as a potential health risk, and minimize exposure to the materials. Each facility is responsible for maintaining awareness of OSHA regulations regarding safe handling of chemicals and associated equipment used in this method.
- The salts of peroxydisulfate ($\text{Na}_2\text{S}_2\text{O}_8$ and others) and solutions containing these salts are strong oxidizers, and corrosive and toxic materials. Handle pure materials and diluted solutions of these compounds in a manner consistent with OSHA regulations. Wear appropriate skin and eye protection when handling any materials containing these salts. Exercise caution when handling these salts or solutions containing these salts in the presence of organic materials, which could result in accidental contact.
- Potassium biphthalate and sodium carbonate are chemical irritants to human skin and eyes. Handle pure materials and stock solutions of these compounds in a manner consistent with OSHA regulations. Wear appropriate skin and eye protection when handling any materials containing these substances. Avoid exposure to fumes or dust.
- Hydrochloric and phosphoric acids have been identified as a corrosive and toxic materials. Handle pure material and diluted solutions of this compound in a manner consistent with OSHA regulations. Wear appropriate skin and eye protection when handling any materials containing this substance.

Reagent Preparation Precautions



WARNING The toxicity or potential health risk hazard of chemicals used in these methods have not been precisely defined. Treat all chemicals and samples as potential health risks.

Minimize exposure to these materials. Each laboratory is responsible for maintaining awareness of OSHA regulations regarding safe handling of chemicals and associated equipment used in these methods



WARNING Mixing acid with water generates a great amount of heat. Take appropriate precautions.

Reagent water: Xylem recommends using distilled or deionized (DI) water containing less than 200 ppb TOC.

Sodium persulfate ($\text{Na}_2\text{S}_2\text{O}_8$) 10% solution or 100g/L: Prepare a 10% $\text{Na}_2\text{S}_2\text{O}_8$ solution by adding 100g of $\text{Na}_2\text{S}_2\text{O}_8$ to 1 L of reagent water (see above). It may be necessary to place the volumetric flask on a magnetic stirrer and stir for approximately 30 to 60 minutes. Ensure that all the sodium persulfate is dissolved into the solution.

Phosphoric acid (5% vol/vol): Prepare a 5% H_3PO_4 by adding 59 mL of ACS reagent grade 85% H_3PO_4 to reagent water for a total volume of 1 L. Reagent H_3PO_4 (part #169244) is available from Xylem.

If suspecting high organic contamination, purify the acid solution by adding 10 mL of persulfate solution and immersing the vented container in boiling water for at least two hours. The persulfate oxidizes any TOC in the solution and then completely auto-degrades in two hours at 100 °C. Purge the cooled solution for several minutes to remove any CO_2 from oxidation of organics. The decrease in reagent blank resulting from this procedure is not generally worth the purification effort unless the acid solution is found to be abnormally high in TOC.

Safety Symbols

The following symbols may be located on the instrument:



Warning/Caution, see accompanying instruction for more information.



Indicates alternating current.



Indicates a hot surface



Indicates hazardous voltages.



Indicates the Protective Earth terminal.



Indicates the OFF position on the power switch.



Indicates the ON position on the power switch.

2. Instrument Components

This chapter identifies the location and provides descriptions of 9220 Online TOC Analyzer components.

2.1 Components - Front View (and Mounting Dimensions)

The 9220 TOC instrument has a hinged, outer translucent polycarbonate cover that protects all internal components. Latches to retain this cover are located on the top, bottom, and right sides of the unit, while a padlock hole allows for securing the cover. The power switch is located to the top left of the unit. Inside this main cover, the 9220 has two compartments: the upper Electronics Compartment, and the lower Analytical Compartment (Figure 2.1).

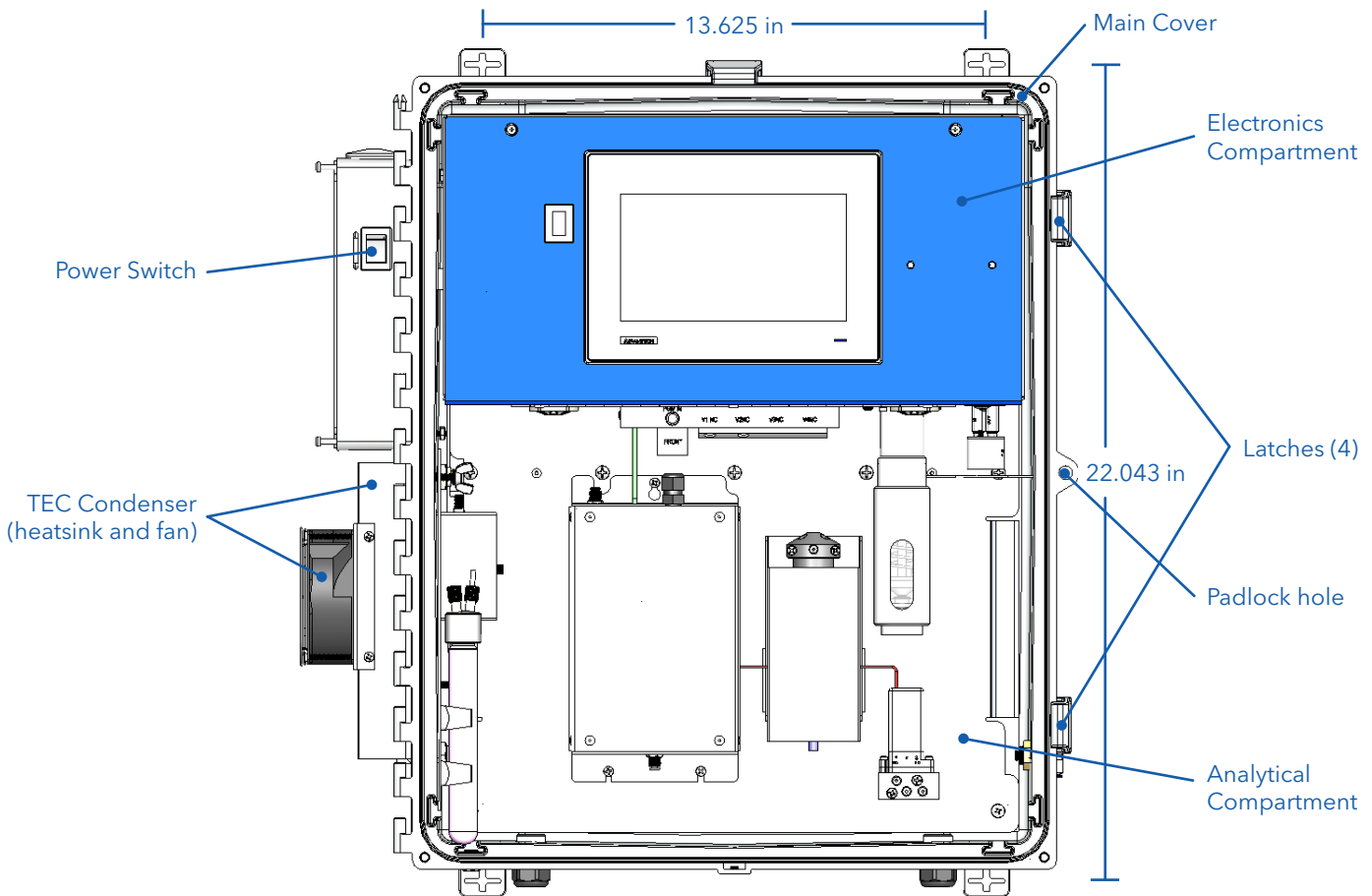

Figure 2.1 9220 Front View

2.2 Components - Left Side View

The left side of the instrument has an Electrical Connection Module (for all external power and other electrical connections), a PGM inlet and outlet fittings, and a TEC cooler module heatsink and fan (Figure 2.2).

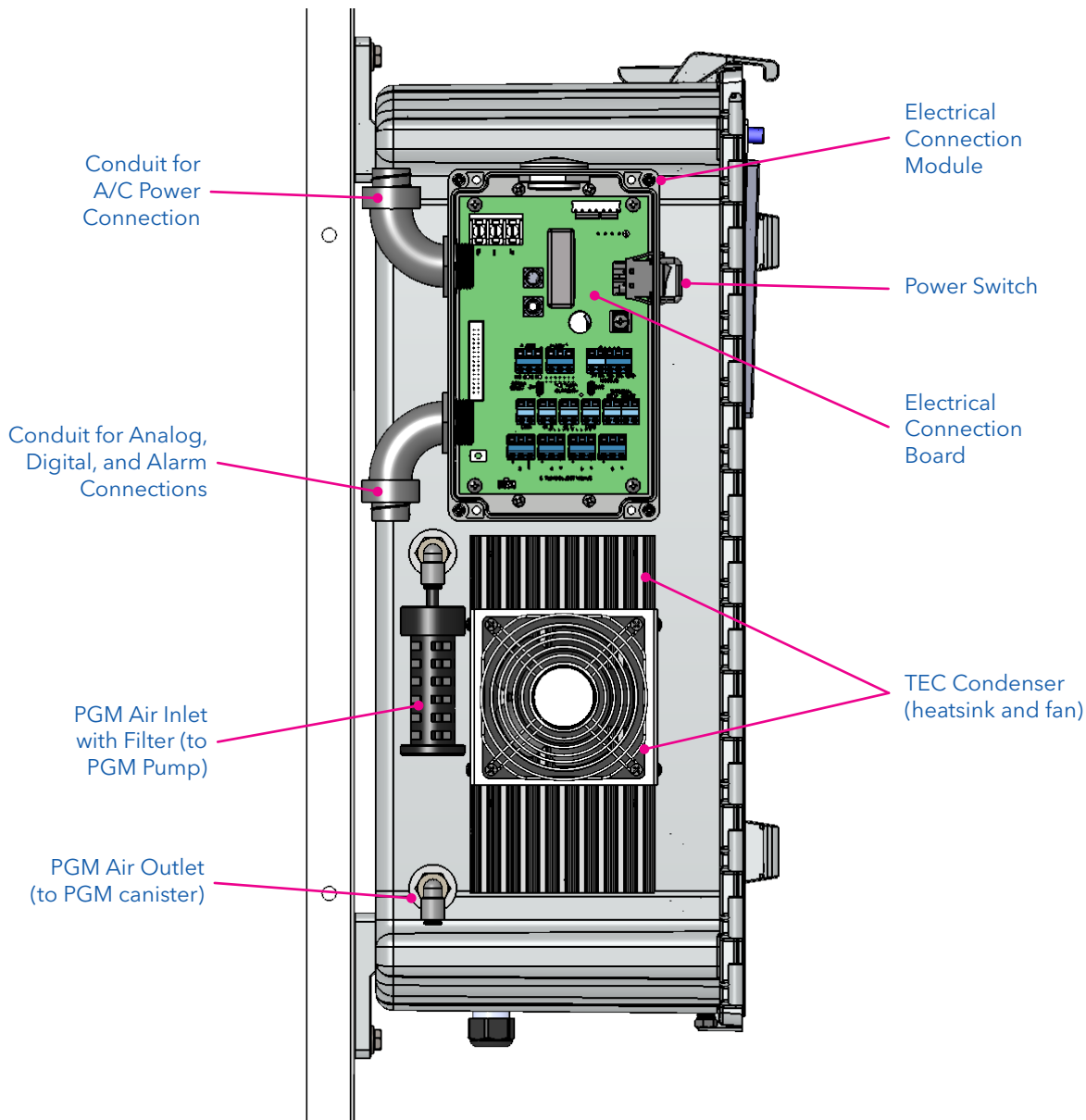

Figure 2.2 9220 Left Side View

The **Process Gas Module (PGM)** is used to provide CO₂-free air to operate the instrument, thus eliminating the need for a compressed-gas cylinder. This module consists of a PGM Pump Assembly, PGM Accumulator Assembly, and an Inlet Filter and CO₂-scrubbing media. The output of the PGM is supplied as the input to the Carrier Gas Inlet Port.

The **PGM Inlet Port and Filter** is the main entry point for room air that will be scrubbed for CO₂ and pressurized to 16psig.

The **TEC Module (heatsink and fan)** is used to remove heat from the internal TEC Module and allow it to cool to 2° C to remove moisture from the CO₂-laden carrier gas going to the NDIR detector.

NOTE: If the 9220 unit is being used in a controlled temperature environment (< 25° C), the fan can be unplugged to reduce the noise. However, if the TEC module cannot maintain the 2° C set point, then the fan must be used.

NOTE: Refer to **Section 3: Installation** for electrical connections.

2.3 Components - Right Side View

The right side of the instrument has door latches, a padlock hole, and an NDIR Vent Line (OUT) port (Figure 2.3).

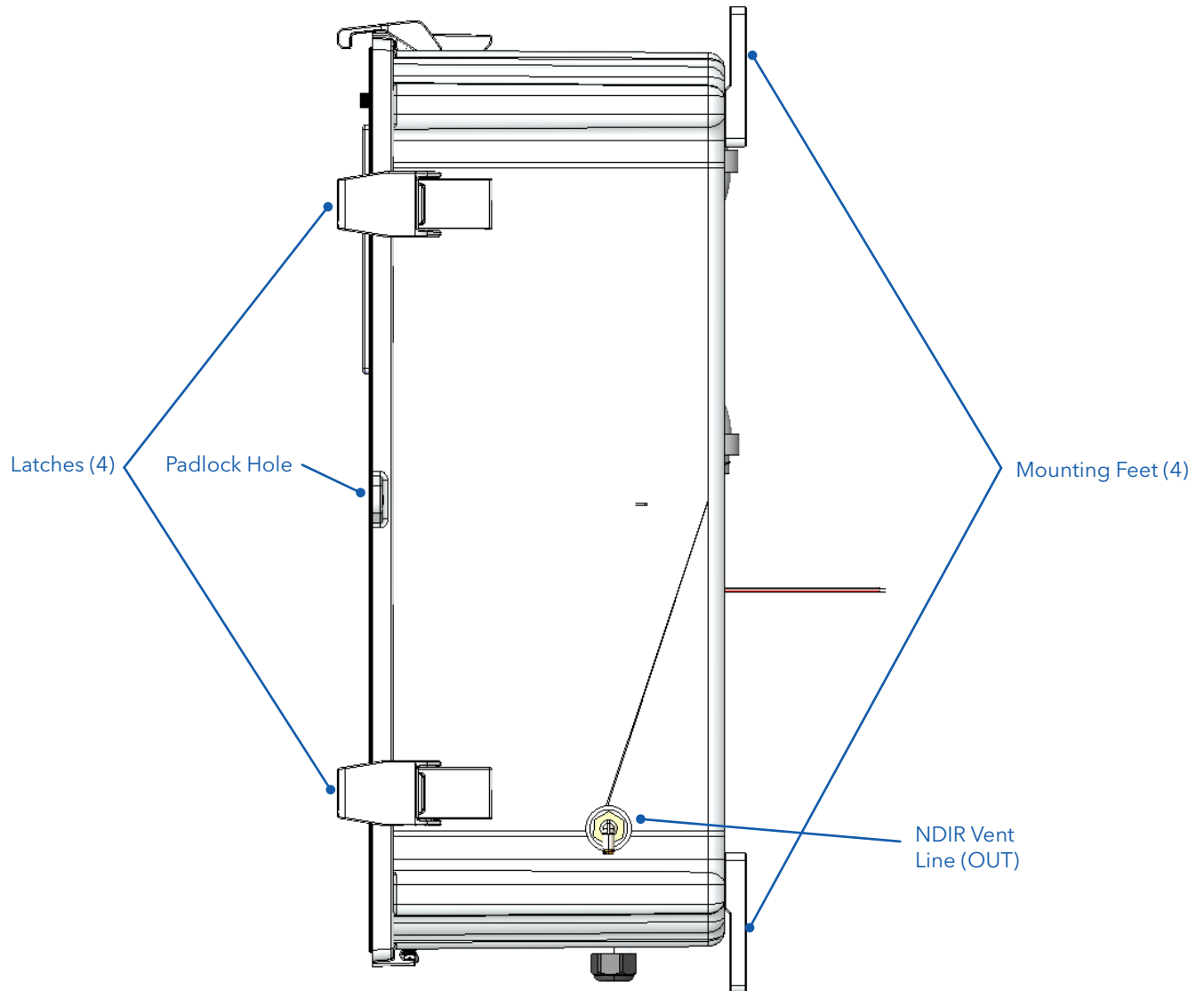

Figure 2.3 9220 Right Side View

The **NDIR Vent** is the exhaust port of the CO₂-laden sample carrier gas from the NDIR detector.

NOTE: Do NOT block or restrict this port in any way during normal operations. Blocking this port can significantly affect the operations of the unit, and possibly cause the NDIR and/or entire 9220 system to flood.

2.4 Components - Rear View (and Mounting Dimensions)

The rear of the 9220 provides the mounting feet. The default orientation of the mounting feet is optimized for the 9220 Mounting Panel (Figure 2.4).

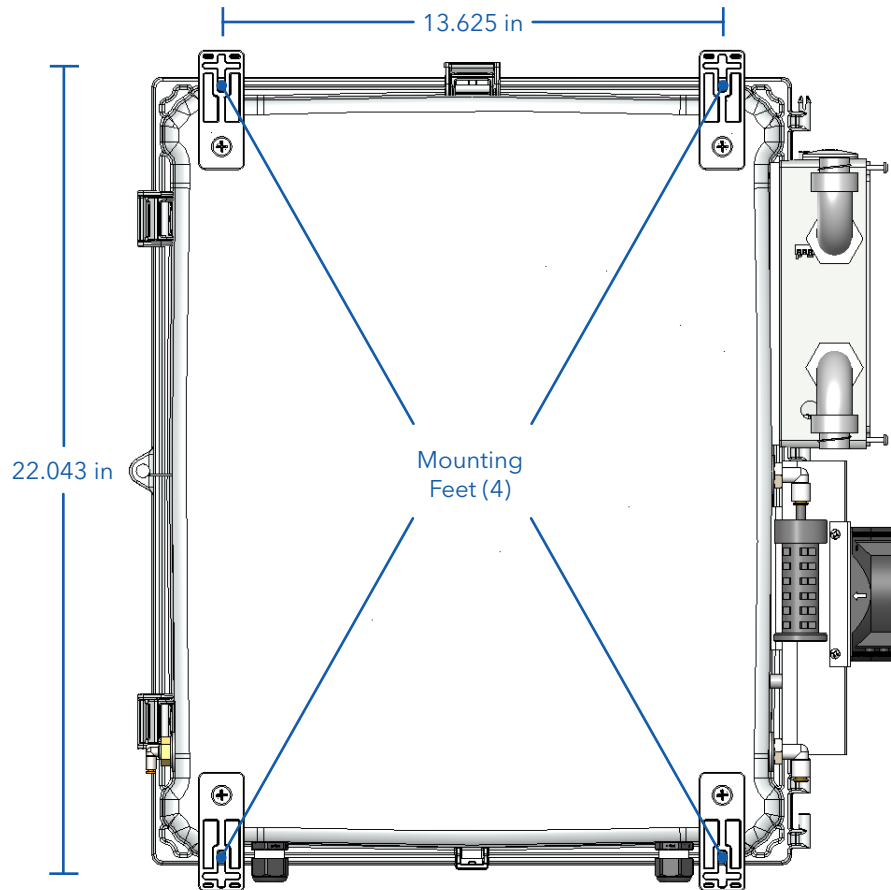

Figure 2.4 9220 Rear View

The **Upper and Lower Mounting Feet** provide the means of hanging the 9220 unit, using a standard $\frac{1}{4}$ " - 20 hex head bolt, or equivalent.

2.5 Components - Bottom View

The bottom of the 9220 enclosure has two 6-port pass-through fittings for twelve 1/8" OD fluid/gas tubes. The fitting to the left is the Sample Fitting, while the fitting to the right is the System Fitting (Figure 2.5).

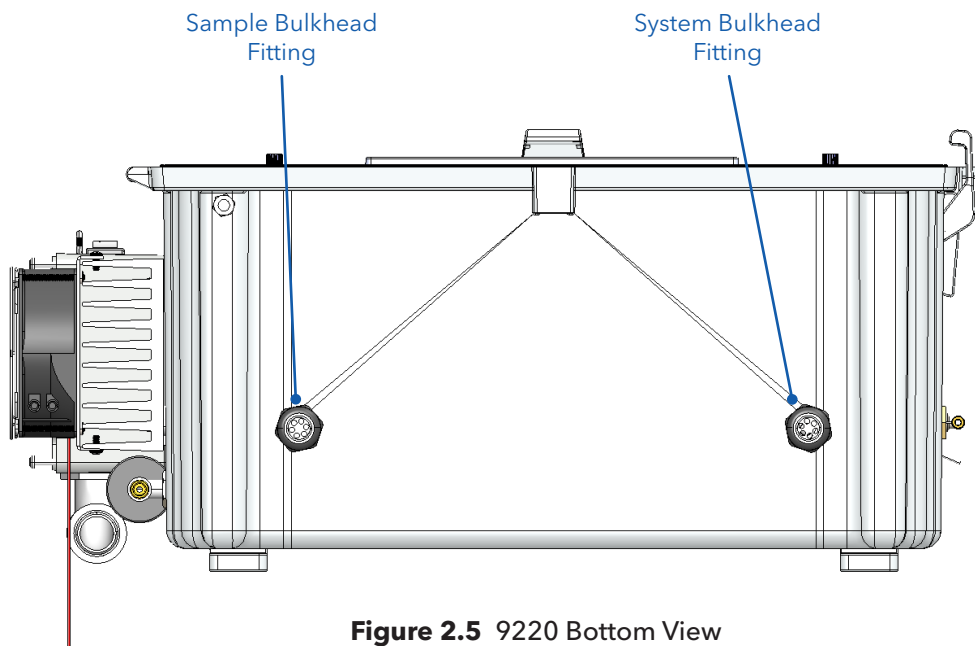

Figure 2.5 9220 Bottom View

Sample Bulkhead Fitting

Sample Bulkhead fitting tubes (various colors) provide the path through which the 9220 acquires the sample to be analyzed. These lines should be connected to either a low-pressure sample source (such as the Sample Inlet Device, part #327114) or to a sample/calibration vial. Refer to **Section 3: Installation** for details on the tubing colors and their purpose.

NOTE: The sample bottles or loops should not be positioned more than 18" from the bottom of the 9220 enclosure.

System Bulkhead Fitting

System Bulkhead fitting tubes (various colors) provide access for the PGM Gas IN, the Waste Out, the acid and persulfate reagents, and the persulfate purge line. Refer to **Section 3: Installation** for details on the tubing colors and their purpose.

2.6 Components - Electronics Compartment (outside)

The upper **Electronic Compartment** houses all critical electronics for the 9220. The outer panel contains the HMI LCD/ Touchscreen module, HMI Power LED, USB port, and the self-retained access screws (Figure 2.6).

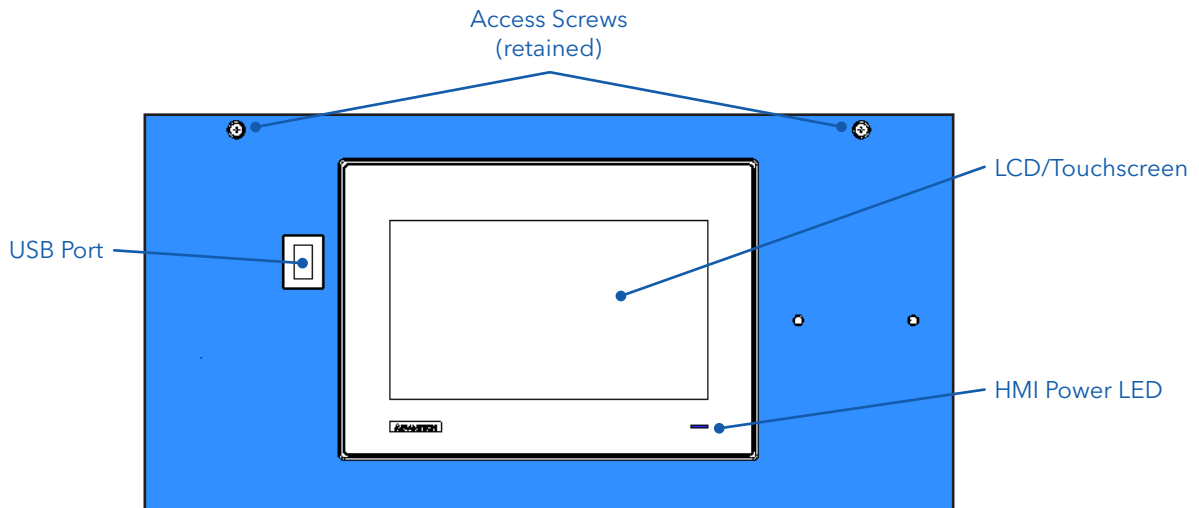

Figure 2.6 9220 Electronics Compartment (outside)

WindowsCE®-Based HMI with LCD Display and Touchscreen provides a full color, touchscreen-enabled operator interface for entering and viewing all system settings and parameters. For details on the User Interface, refer to **Section 4: User Interface**.



CAUTION: The 9220 touchscreen uses an LCD, which is designed for operators to initiate commands by pressing a finger on the screen. Avoid striking or using excessive pressure on the touchscreen to prevent damage to the LCD/touchscreen. It is recommended that operators apply light pressure to the screen for the best sensitivity. Avoid direct spray of water or other chemicals on the LCD/ touchscreen.

To ensure the longest possible service life for the LCD module, always keep the outer cover closed except when servicing. **DO NOT** perform any washdown cleaning of the 9220 system without the door being closed and fully latched to provide maximum water ingress protection.

USB Port allows the operator to collect data from the 9220 system. It also allows the operator to perform system software and firmware updates as updates become available.

2.7 Components - Electronics Compartment (inside)

Inside the **Electronics Compartment**, the following components are installed: main control board and power supply, along with the electronic portions of the syringe pump, 6-port system/sample valves, persulfate and PGM pumps, and flow valves (Figure 2.7).

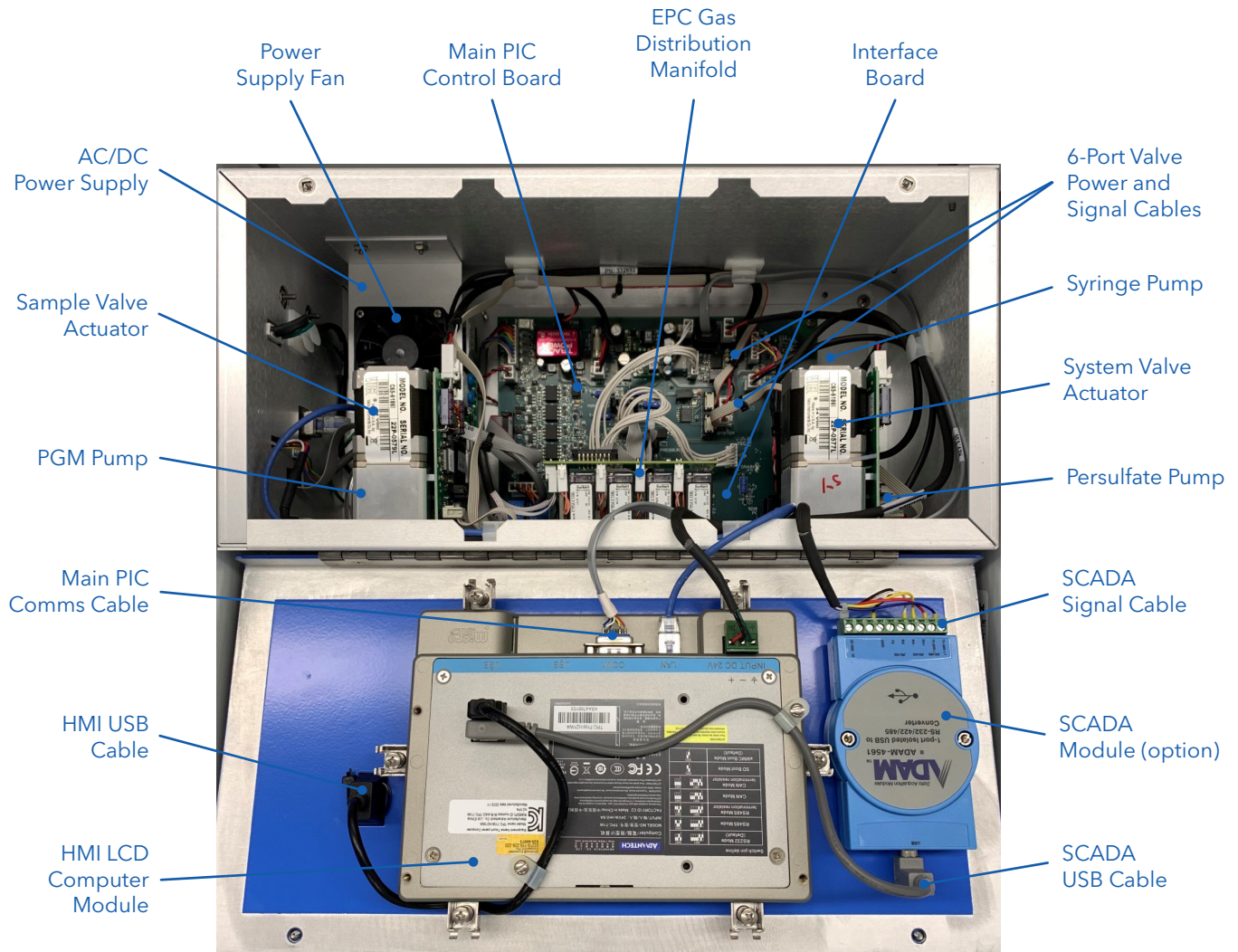

Figure 2.7 9220 Electronics Compartment (inside)

- The **AC/DC Power Supply** converts the incoming 100-240 VAC power to DC, which drives all the internal electronics.
- The **Power Supply Fan** circulates air over the power supply heat sink.
- The **Main PIC Control Board** provides electronic control for all internal and external system hardware, including the 6-port system and sample valves, EPC valves, syringe pump, persulfate pump, PGM pump, and drain valve. It also interfaces with the NDIR detector module and HMI LCD module.
- The **EPC Gas Distribution Manifold** utilizes a variable valve and two pressure sensors to create an Electronic Pressure Controller (EPC), which regulates the system pressure at 13psig to generate the main carrier flow and the other gas flows in the system. The four discrete valves direct the flow to specific ports as needed to process the sample.
- The **Interface Board** provides electrical connection and distribution from the main PIC control board to the analytical compartment of the instrument, including the Thermoelectric Cooler (TEC), NDIR, TOC reactor, and drain valve.
- The **Syringe Pump Actuator** drives the syringe plunger up and down to push and pull samples, reagents, and gases as needed during sample processing.
- The **Sample Valve Actuator** controls the rotation of the 6-port sample valve to allow the system to acquire standards and samples as needed to support the defined sampling sequence.
- The **System Valve Actuator** controls the rotation of the 6-port system valve to allow the system to move samples and gases as needed to process samples.
- The **PGM Pump** draws outside air through a filter and compresses it into the external canister through the CO₂ scrubber media. This compressed gas (less than 20psig) is then supplied to the EPC manifold to be used for all system flow. This eliminates the need for an external compressed gas cylinder or compressor.
- The **Persulfate Pump** draws persulfate from the reservoir and injects it into the TOC reactor as needed. A check valve ensures the persulfate does not flow back into the reservoir.
- The **HMI LCD/Touchscreen Module** provides the main processing computer and Graphical User Interface (GUI) for operator interaction. This module communicates with the main PIC control board and the NDIR detector module to perform the sample sequence and analysis. After completing the sample calculations and data storage, the module presents data to the operator on the LCD screen for review. It also supports SCADA, Ethernet, and USB accessories.
- The **SCADA Module** is a built-in feature that allows the operator to remotely control the 9220 system using a defined set of commands and responses. Contact technical support for additional information.
- The **HMI Daughter PCA** provides inter-connection and power distribution to two components on the front panel.

2.8 Components - Analytical Compartment

The lower **Analytical Compartment** provides access to the analytical and fluid handling components, including the syringe module, 6-port system valve and sample valve, TOC reactor, gas distribution manifold, TEC condenser module, persulfate pump, drain valve, and NDIR detector (Figure 2.8).

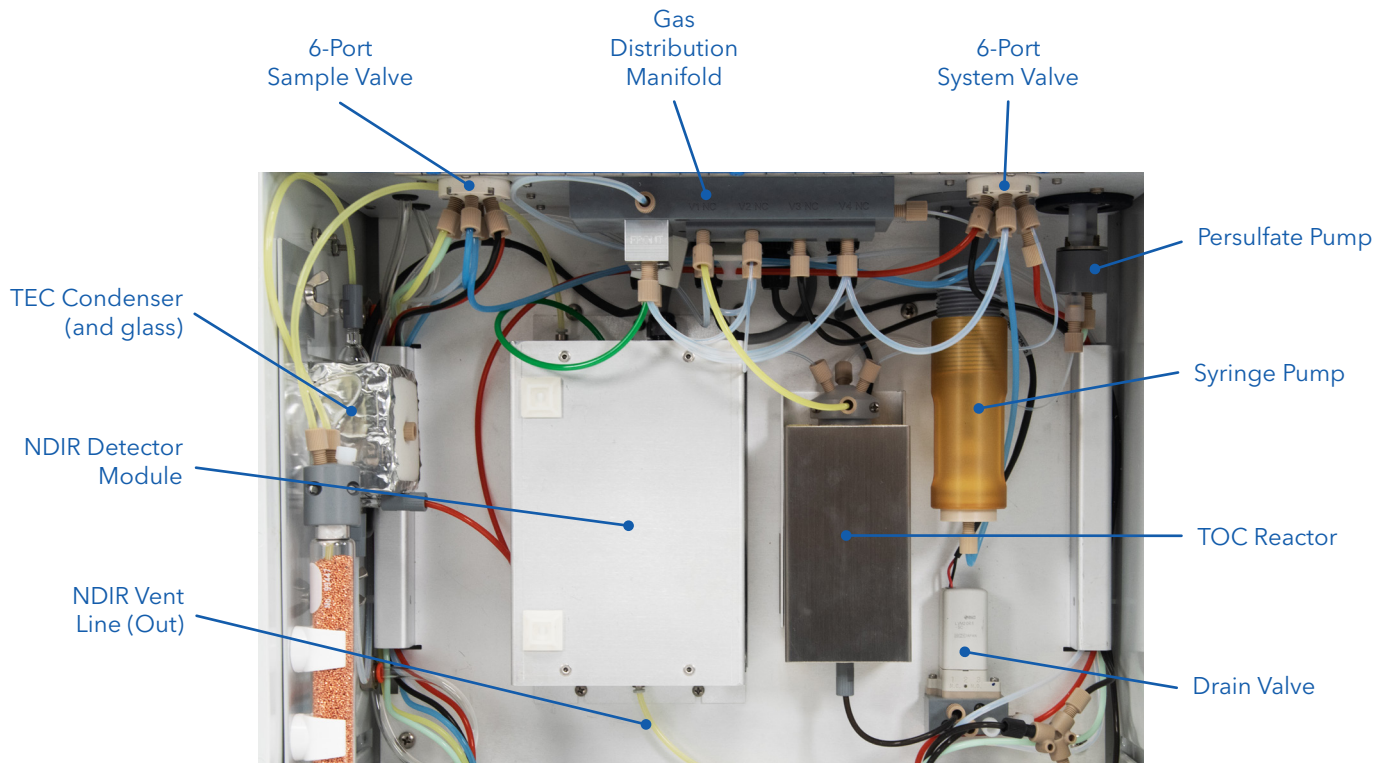

Figure 2.8 9220 Analytical Compartment

- The **Gas Distribution Manifold** consists of four inert, liquid-isolation solenoid-operated valves, which are used to direct gas and liquids to components in the sample-processing loop, EPC, and four flow restrictors (with integral check valves). The flow rates generated are as follows:
 - Main carrier flow = 65mL/min \pm 7.0 (nominal)
 - TIC Purge flow = 85mL/min \pm 10.0 (nominal)
 - NDIR Purge flow = 5mL/min (nominal)
 - Persulfate Purge flow = 20mL/min
- **NOTE:** *These flow rates will change during the run as flows are stopped and started.*
- The **NDIR Detector Module** measures the CO₂ concentration in the gas stream. The NDIR detector is mounted in an insulated box and maintained at a temperature of 45 °C or higher (depending on ambient temperature). This reduces the possibility of condensation forming in the detector from the incoming carrier gas stream and stabilizes the NDIR performance across the dynamic ambient temperature range of the 9220 system.
- The **TOC Reactor Module** contains an all-glass sample pathway and a reactor heater block to heat the sample up to 98 °C while sodium persulfate is added to perform the oxidation.
- The **Syringe Pump** is the motive force for priming, aspirating, and transferring samples and reagents. The TIC removal step is also conducted within the syringe before transferring a TIC-free sample into the TOC reaction chamber.
- The **6-Port System Valve** provides the syringe pump (connected to the common center port) with selective access to the sample, acid, process gas, TOC reaction chamber, and waste ports.
- The **6-Port Sample Valve** provides the system valve (connected to the common center port) access to a selection of up to 4 different samples and 2 standards. The lines from ports 1-6 of this valve are connected to standards containers and sample inlet devices.
- The **Thermoelectric Cooler (TEC)** cools an aluminum block fitted with a condensation trap down to approximately 2 °C (depending on ambient temperature), removing moisture from the CO₂-laden carrier gas before it enters the SSNDIR detector for measurement.
- The **Condensation Trap** consists of an upper dimpled section that increases contact between the wet vapor and the cool glass wall. Cooling significantly lowers the dew point of the CO₂-laden carrier gas causing condensate to form and catch in the lower section of the trap. The syringe automatically drains away the condensate after each sample.
- The **Drain Valve** consists of a manifold and a 2-way valve that connects the TOC reactor drain line to a zero-pressure drain that exits the bottom of the instrument housing.

3. Installation

This chapter includes step-by-step procedures for properly installing the 9220. It lists the materials needed for installation that are not included with the basic instrument. Xylem recommends completing the site requirements checklist and gathering materials before attempting the installation. Refer to Xylem document [XA00285 - 9220 Process TOC Analyzer Site Preparation Guide](#) prior to installing the analyzer. Refer to [Section 2: Instrument Components](#) for the names and functions of various components when installing the 9220.

3.1 Site Preparation and User-Supplied Materials

Each customer installation requires a site-specific instrument configuration and site preparation for the 9220. Prior to site installation, laboratory analysis of the intended water to be monitored may be required to determine TIC and TOC level baselines. These baselines will help determine site-specific instrument configuration and setup.

Site Preparation

The 9220 should be operated within operating ranges described in the 9220 specifications. Refer to [Section 1: Instrument Specifications](#).

- **Environmental**

The 9220 should be operated out of direct sunlight and in temperatures above 5 °C and below 45 °C. If the 9220 is mounted outside, it should be protected above and on at least three sides from direct sunlight, rain, sleet, and snow. Additionally, if the humidity approaches the operational limit, an additional coalescing filter may be necessary to collect water generated by the PGM pump.

- **Power**

The site is required to provide 100-240 VAC (50/60 Hz) power to the 9220.

- **Waste Management**

The site must plan to collect analyzer liquid waste into either a zero-pressure floor drain or a waste container. The waste will contain approximately 1% phosphoric acid and 2% sodium persulfate. Collect and dispose of any generated waste in accordance with local ordinances and safety precautions.

NOTE: Do not submerge the 9220 Drain line below the maximum water level of the waste container. Placing the drain line below the water level can make it difficult for the 9220 the drain properly and cause instrument performance issues and possible product failure.

- **Process Gas**

The Process Gas Module (PGM) is included with each 9220 system as a standard feature. Therefore, no external compressed gas is required.

- **Sample**

The site will need to provide samples to the 9220 using the fill-and-spill sampling system or site-supplied ambient-pressure sampling source.

- **Power/Safety Disconnect**

To ensure safe operation and maintenance of this system, an external power/safety disconnect for the live AC mains must be provided (not included with this 9220 system). This disconnect box (breaker or switch) must be installed within 6 ft (2m) of the 9220 system and wired between the AC mains power and the 9220 system. It must be clearly marked with ON/OFF positions, and must open both poles at the same time. A single-pole switch/breaker is not acceptable.

When installing and/or servicing the 9220 system, the power/safety disconnect MUST be in the OFF (disconnected) position to remove AC power from the 9220 system.

User-Supplied Materials

For a typical installation, the operator must have several items on-hand before installing the 9220. The following are required installation materials:

- **High Purity Water**

Source of high-purity water, TOC 200ppb C or less.

NOTE: For TOC analysis below 1ppm, reagent water must contain less than 50 ppb C.

- **Calibration Standards**

Low Standard: High-purity water can be used for the "low" calibration standard.

High Standard: The default full-scale range of the 9220 is 25 ppm. However, the full-scale range can be adjusted from 10 to 100 ppm. The high standard should match the desired full-scale range.

Mid-level Standards: If using more than two standards in the calibration curve, the mid-level standard concentrations must fall between the low and high values.

- **Reagents**

The 9220 requires the use of a 5% phosphoric acid solution and a 10% sodium persulfate solution for operation of the instrument. Refer to Appendix A Reagent Preparation.

3.2 Hardware Installation

After opening the shipping container, unpack the instrument and check the contents against the packing list. If any damage is apparent, immediately notify the carrier and YSI Customer Support. Save all packing materials until proper operation of the analyzer is verified.

Tools Needed for Installation

- 7/16" open end wrench (x2), or adjustable wrench (x2)
- #2 Philips head screwdriver
- #2 Flat screwdriver
- 3/8" or 1/2" Drill driver (Optional; for wall mounting of panel)

Equipment Needed for Installation

- Calibrated Flow meter 0-500 mL/min
- Calibrated Pressure gauge with 1/4"-28-T fitting 0-30 psi
- Various 1/8" O.D. tubing lengths, plus 1/4"-28 fittings and ferrules

3.3 Installing the Mounting Panel and 9220 TOC

Mount the 9220 Unit

The 9220 TOC is intended to be installed with the mounting panel (part #333206) that is supplied with the instrument.

After opening the instrument shipping package, remove the startup kit (part #333212) and inspect it for completeness. Component lists are included in the kit.

1. Remove the 9220 mounting panel from the package. Assemble it according to the instructions that are included with the panel. Locate it near a suitable 100-240 VAC (50/60Hz) electrical power source, sample lines, and drain point. A panel position with the top of the panel at six feet from the floor is an ideal position for most operators.
2. For the PGM assembly and installation, follow the instructions included in the kit.
3. Install the (4) upper and lower mounting feet using the hardware provided, as shown in Figure 3.1.
4. Using the upper and lower mounting feet, firmly mount the 9220 to the mounting panel with (4) ¼"-20 x 1" bolts.
5. Mount the PGM canister in the position provided on the mounting panel.
6. Connect the ¼-inch OD tubing supplied in the PGM kit to the PGM outlet port on the left-hand side of the 9220. Connect the other end of the tubing to the PGM IN port on the cap of the PGM canister. Connect the clear, 1/8-inch OD tubing from the System Bulkhead fitting to the PGM OUT port on the PGM canister.
7. Install the Sample Inlet Device(s). The 9220 TOC can accept up to (4) Sample Inlet Devices. The mounting positions are near the bottom of the panel in the center. Cutouts in the reagent tray allow the inlet and outlet ports to pass through the tray. The Sample Inlet Devices can be installed in any position; however, it is convenient to start left-to-right and designate the devices as Streams 3, 4, 5, and 6. Attach 1.5-inch clamps to hold the Sample Inlet Device using the 8-32 screws provided in the startup kit. Position the Sample Inlet Device in the clamp and tighten the clamp. See Figures 3.3 and 3.4.
8. A drawing of a complete 9220 and mounting panel assembly is shown in Figure 3.3.

NOTE: If not using the 9220 mounting panel, provide 18 inches below the unit for access to the waste port, acid inlet line, persulfate lines, and sample inlet line. Allow at least 12 inches above and on the instrument's left- and right-hand sides. A suitable shelf must be provided to hold the reagent bottles and must be located no more than 18 inches below the instrument. The PGM canister must be installed on the left-hand side of the 9220 and 8 inches below the 9220.

NOTE: Any suitable stand, which is designed for mounting process instrumentation, can be used to mount the instrument. Ensure the 9220 panel is securely mounted at the four mounting points, as shown in Figure 3.1. If a freestanding stand is used for mounting, ensure that it is leveled and secured to the floor. If the base of the stand is not required, ensure that the vertical section or panel is secured to a wall.

9. Remove the transport plug from the NDIR vent port on the right side of the 9220 as show in Figure 3.2.

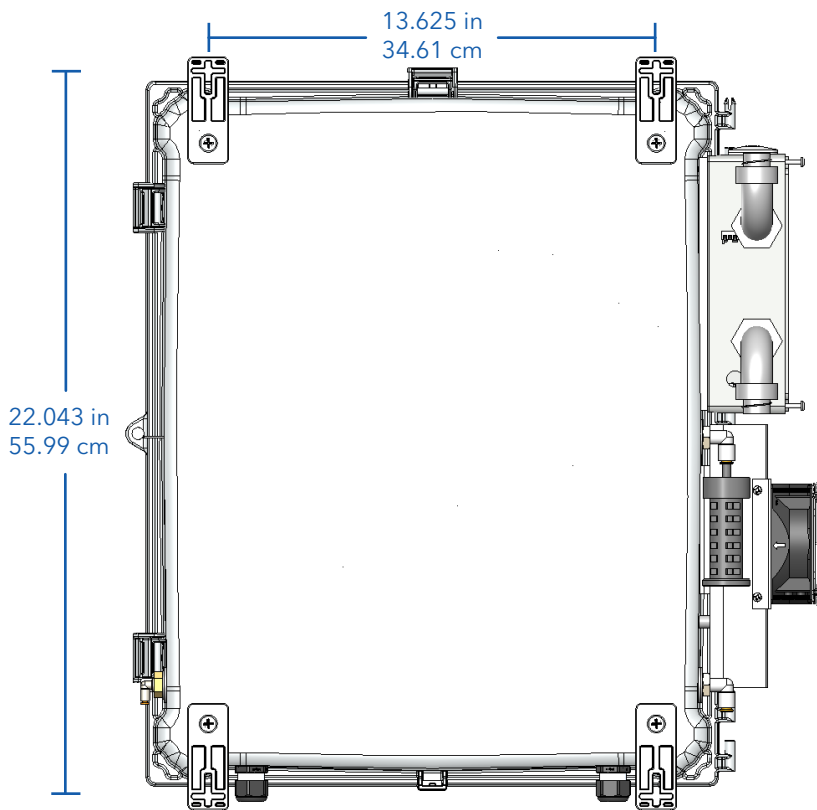

Figure 3.1 9220 Back View with TEC Heat Sink

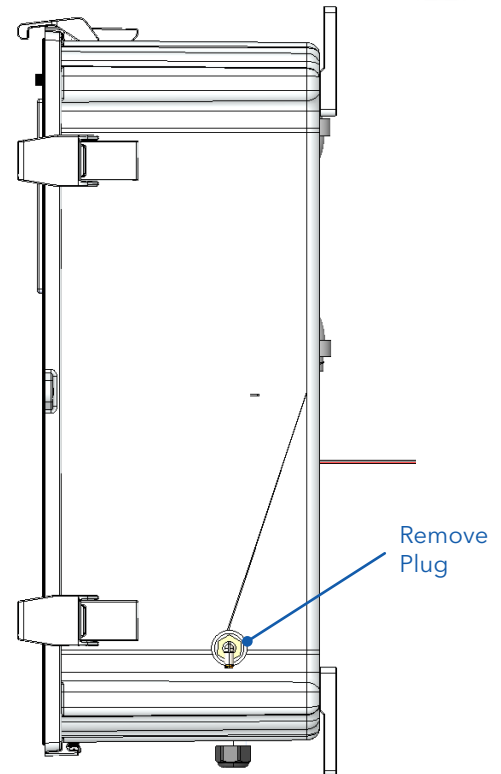

Figure 3.2 9220 Right Side View

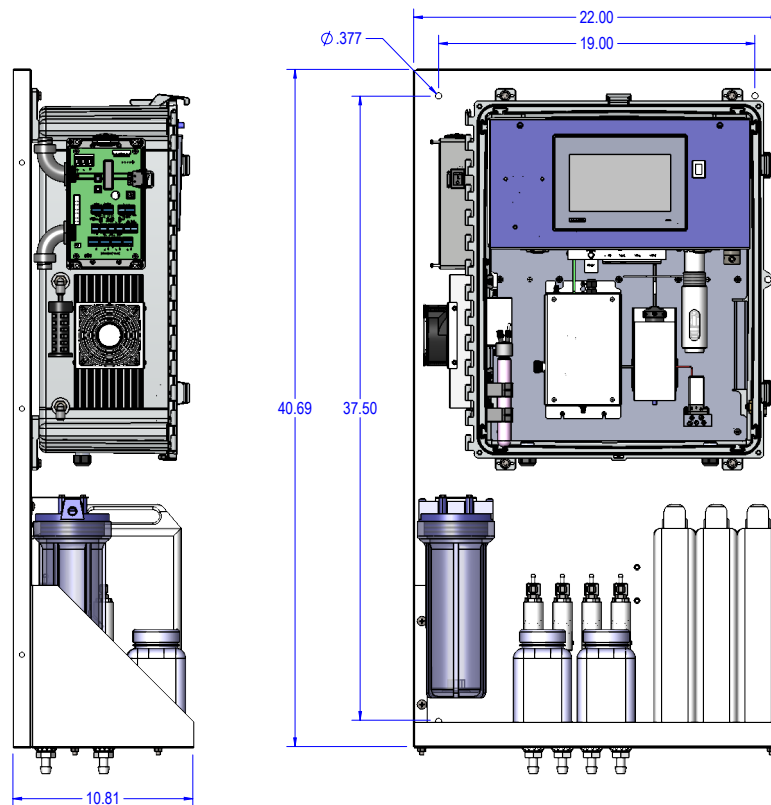

Figure 3.3 9220 Mounting Rack Installation

Make the Plumbing Connections

Connect all plumbing lines to the 9220 TOC unit via the sample and system bulkhead fittings.



Sample Bulkhead Connections

Tube #	Color	Name	Purpose/Usage	Sample Valve Port #
1	Blue	STD #1	Cal STD (Low STD, DI Water)	1
2	Yellow	STD #2	Cal STD (High STD, if 2-pt Cal)	2
3	Green	STD #3 or SPL #3	Cal STD (if multi-point Cal) or Sample #3	3
4	Clear	STD #4 or SPL #4	Cal STD (if multi-point Cal) or Sample #4	4
5	Red	STD #5 or SPL #5	Cal STD (if multi-point Cal) or Sample #5	5
6	Black	SPL #6	Sample #6	6

- The **STD Ports** are those ports used to acquire the user-supplied standards (or validation standards) for system calibration/validation. Typically, these are KHP standards. These low- to zero-pressure standards are drawn into the 9220 as needed based on the sequencing process.
- The **SPL Ports** are those ports used to acquire the unknown samples to be analyzed for TOC content. These low/zero-pressure samples are drawn into the 9220 as needed based on the sequencing process. These ports can also use the optional fill-and-spill sample loops and external sample valves to manage the sample flow from the site's various process lines.

Here are some typical system configurations:

Example 1: 2-point calibration curve and 4 samples

- Port 1: STD1 = DI Water
- Port 2: STD2 = High STD (e.g., 25ppm KHP)
- Port 3: SPL3 = User sample #3
- Port 4: SPL4 = User sample #4
- Port 5: SPL5 = User sample #5
- Port 6: SPL6 = User sample #6

Example 2: 2-point calibration curve with mid-range QC and 3 samples

- Port 1: STD1 = DI Water
- Port 2: STD2 = Mid STD / Validation (e.g., 10 ppm KHP)
- Port 3: STD2 = High STD (e.g., 25ppm KHP)
- Port 4: SPL4 = User sample #4
- Port 5: SPL5 = User sample #5
- Port 6: SPL6 = User sample #6

NOTE: The optional fill-and-spill sample loops and external sample valves can only be associated with ports 3-6. The external valves are connected to the external connection box through conduit lines. Refer to **Section 4: User Interface** for more details on configuring and programming these valve control settings.

Tube #	Color	Name	Purpose/Usage
1	Clear	PGM Gas (IN)	CO ₂ -free gas from PGM to EPC (IN)
2	Black	Waste	TOC Reactor Drain (OUT)
3	Black	Waste	Syringe Waste (OUT)
4	Black	Waste	Syringe Vent (OUT)
5	Red	Acid	Phosphoric Acid (IN)
6	Green	Persulfate	Persulfate (IN) to Persulfate Pump

- The **PGM Gas (IN) Port** is the main entry point for supplying carrier gas to the 9220. This port connects the outlet of the PGM canister to the gas IN port of the EPC manifold.
- The **Waste (OUT)** lines allow the system to remove sample waste from the system. There are three (3) separate waste lines:
 - TOC reactor waste line uses gas to expel the processed sample.
 - Syringe waste line allows the syringe to expel excess sample.
 - Syringe vent line allows the syringe to purge CO₂ from TIC before transferring to TOC reactor.

NOTE: The waste lines must be directed to a floor drain or zero-pressure waste receptacle via an oversized waste line (1/4" diameter or greater) with a vacuum break. The top of that oversized waste line must be below the height of the drain fitting to allow the gravity drain to work properly. The bottom of that waste line should NOT be underwater in the waste receptacle. Otherwise, system flooding may occur.

- The **Sodium Persulfate Inlet (green tubing)** allows the persulfate pump in the 9220 to draw persulfate from the reagent container and inject it into the TOC reactor. This line should be connected to a low-pressure container of 10% sodium persulfate. A check valve is used on the persulfate pump to resist the persulfate in the line from backflowing into the reagent container.

NOTE: The bottom of the persulfate container should not be positioned more than 18 inches below the bottom of the 9220 enclosure.

- The **Phosphoric Acid Inlet (red tubing)** allows the 9220 to draw the acid used to perform TIC removal. This line should be connected to a low-pressure container of 5% phosphoric acid. A check valve is used on the acid line to prevent the acid from backflowing from the system valve back into the reagent container.

NOTE: The bottom of the acid container should not be positioned more than 18 inches below the bottom of the 9220 enclosure.

Positioning the Standard and Reagent Bottles

Position and connect the standards and samples.

1. Connect the 1/8" blue line to the STD #1 (DI water) container.
2. Connect the 1/8" yellow line to the STD #2 (Cal high) container.
3. Connect the 1/8" green line to the sample #3 source or the STD #3 container.
4. Connect the 1/8" clear line to the sample #4 source or the STD #4 container.
5. Connect the 1/8" red line to the sample #5 source or the STD #5 container.
6. Connect the 1/8" black line to the sample #6 source.

Position the standard and reagent bottles on the rack underneath the 9220. For bottle placement. See Figure 3.4.

7. Connect the 1/8" red acid reagent line to the phosphoric acid container.
8. Connect the 1/8" green persulfate reagent line to the persulfate container.
9. Connect the 1/8" clear line to the persulfate container.
10. Connect the three (3) 1/8" black waste lines to the oversized waste line.



Figure 3.4 Acid, Sample, Persulfate, and Drain Lines

Power and Data Connections

All 9220 electrical and communication connections are made in the external connection box of the 9220 unit via 3/4" conduit holes in the upper left side of the 9220.

NOTE: Do not apply power until all gas and liquid plumbing connections have been made and all accessories are properly installed.

All 9220 user connections are made to the 9220 external connection board, using fixed and removable screw-down terminal blocks located on the board, as shown in Figure 3.5.

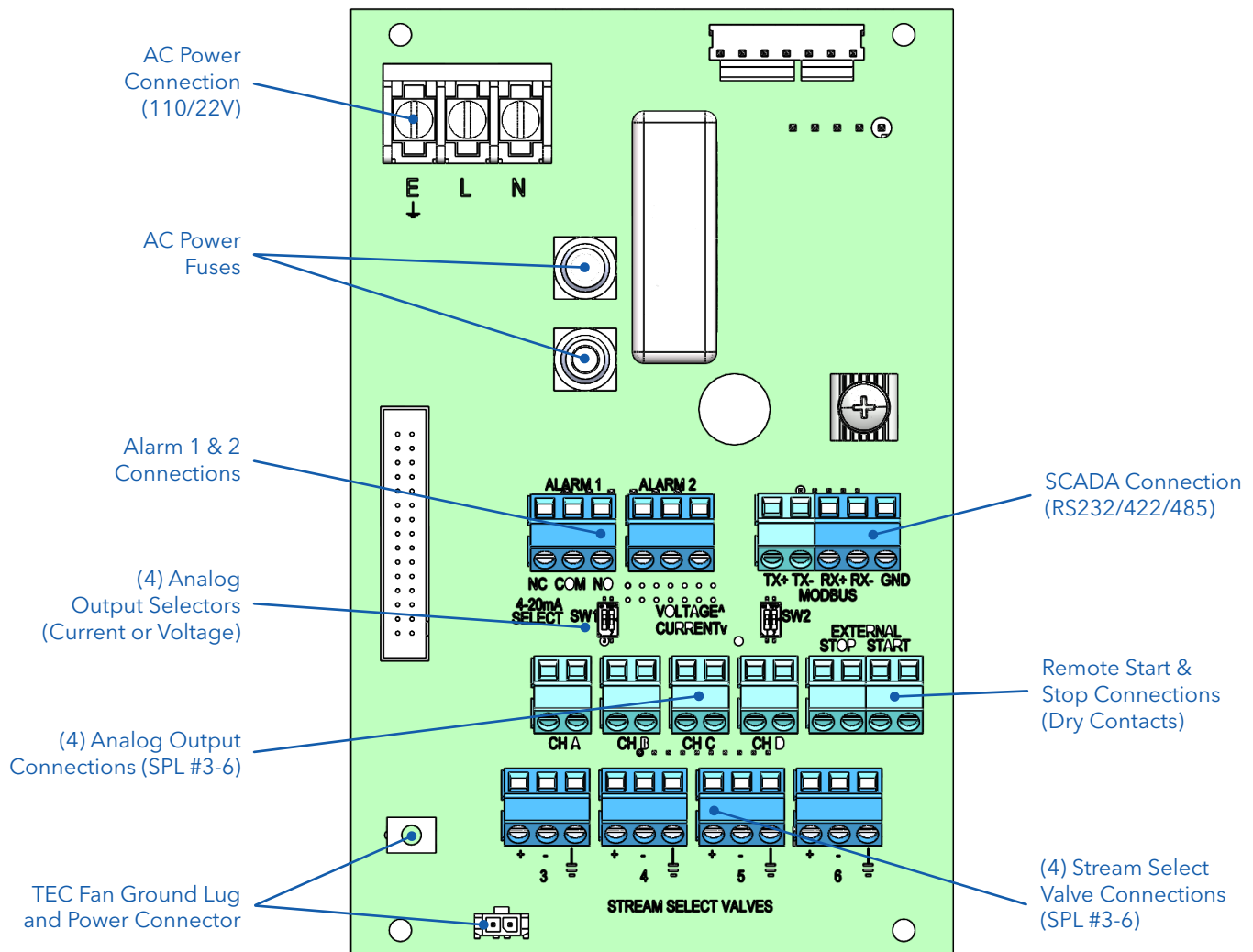
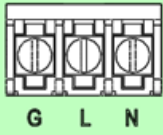

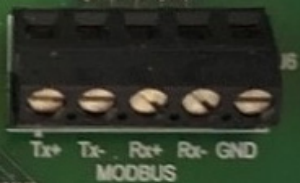

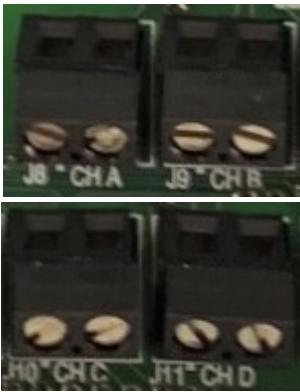



Figure 3.5 9220 Main PIC PCA Layout with User Connections

Connector	Image	Notes
(J2) AC Power (100-240 VAC; 50/60HZ; nominal)		G = Earth (Ground) N = Neutral L = Line
Alarm Outputs (J4) Alarm 1 (J5) Alarm 2		NC = Normally Closed COM = Common NO = Normally Open
(J6) MODBUS (SCADA) (RS232/422/485; selectable)		RS232: Tx+ = Transmit (pos) Tx- = Transmit (neg) Rx+ = Receive (pos) Rx- = Receive (neg) GND = Ground
Analog Output Selector (SW1) CH A and CH B (2-pin Dip Switch)		Pin1 (CH A) Up = Voltage (1-5 VDC) Down = Current (4-20mA) Pin2 (CH B) Up = Voltage (1-5 VDC) Down = Current (4-20mA)
Analog Output Selector (SW2) CH C and CH D (2-pin Dip Switch)		Pin1 (CH C) Up = Voltage (1-5 VDC) Down = Current (4-20mA) Pin2 (CH D) Up = Voltage (1-5 VDC) Down = Current (4-20mA)
Analog Outputs (J8) CH A (J9) CH B (J10) CH C (J11) CH D		For each channel (Self-powered mode): Voltage Mode: Pin1 (left) = negative Pin2 (right) = positive Current Mode: Pin1 (left) = negative Pin2 (right) = positive For each channel (Loop-powered mode): Voltage Mode: (Not Available) Current Mode: Pin1 (left) = positive Pin2 (right) = negative
(J12) Remote Start/Stop (Dry-contact closures)		Short Pin1 and Pin2 under STOP to trigger Remote Stop Short Pin3 and Pin4 under START to trigger Remote Start



Stream Select Valves (J13) Valve 3 (J14) Valve 4 (J15) Valve 5 (J16) Valve 6		Connect leads from each valve to connectors: Pin1 (left) = positive Pin2 (mid) = negative Pin3 (right) = Earth (Ground)
(ZZ1) TEC Ground (J17) TEC Fan		Connect the 2-pin connector from TEC Fan and connect the spade terminal to the ground lug

Table 3.1 9220 Main PIC User Connector Labels

Power and Data Connection Descriptions

- **AC Electrical Power Inlet** is the main AC power entry point for the 9220. The power supplied should be between 100-240 VAC (50/60Hz), nominal.
- **Alarm1/Alarm2** connection provides contact closure output to indicate if system or sample alarms have occurred. Alarm1 indicates a system alarm. Alarm2 indicates a sample alarm. Wire as NC/GND or NO/GND as required to support the attached user-supplied hardware. **Output Rating: DC only; 24VDC (max); 5A (max)**
- **MODBUS (SCADA)** connection provides an interface to remotely communicate and control the 9220 system. This feature requires the optional SCADA module to be installed. RS232, RS422, and RS485 wiring is supported. Contact technical support for additional information on the SCADA MODBUS protocol.
- **Analog Output Selectors** provide the ability to select the mode of each analog output channel (CH A - CH D). The options are current mode (4-20mA) or voltage mode (0-5VDC).

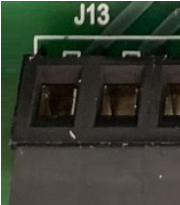
NOTE: The 9220 can also be configured for “Self-Powered” mode (default) or “Loop Powered” mode. This mode can be configured for each channel separately on the 9220 main PIC board, by adjusting the jumpers on JP3 (CH A), JP4 (CH B), JP10 (CH C), and JP11 (CH D). See Figures 3.6a and 3.6b.

- **Analog Output Channels (CH A - CH D)** provide an analog output signal for each of the default sample assignments for ports 3-6.
NOTE: 4-20mA and 1-5VDC are nominal output ranges. The actual maximum range of output is 0-30mA and 0-7VDC. The 0mA low range allows for an error indicator at 2mA. The 30mA high range allows for calibration of the loop to account for line losses. The 9220 software provides the ability to calibrate the 4mA and 20mA levels.
- **Stream Select Valves** provide the ability to automate sampling from up to 4 sample streams using the fill-n-spill sample loops. Refer to **Section 4: User Interface** for programming their use.
- **TEC Fan and Ground** connections provide the ability to power the TEC heatsink fan in ambient temperature environments that exceed 30 °C.



Figure 3.6a
Self-Powered Mode



Figure 3.6b
Loop-Powered Mode

4. 9220 User Interface

This chapter describes the menus, screens, and commands that control the 9220, using the embedded Windows® CE HMI with touchscreen.

The HMI uses a capacitive touchscreen interface, which requires using a finger or capacitive-type stylus for best results. Any icon, dialog box, or edit field can be accessed directly by pressing it on the touchscreen. References made to "clicking," "pressing," or "touching" an icon or other element of the user interface are used interchangeably throughout this manual to mean pressing the touchscreen.

CAUTION: If a stylus is used, always use a capacitive-type stylus for pressing the touch screen on the 9220. Using sharp or pointed objects, such as screwdrivers or ball-point pens, will not work and may damage the touch screen and display.

4.1 Logging Into the 9220 Software

The 9220 software includes built-in security features to restrict access to specific users.

The system uses a basic, two-level security scheme with two user-definable User ID accounts available. These accounts are created for the following security levels:

- **Operator** offers basic operations, such as Start and Stop as well as reviewing the current result data. However, no advanced functions (such as Config and Maint) are permitted.
- **Administrator** offers full access to all features of the software.

The usernames and passwords for these two accounts are stored on the device and can only be accessed and modified via the 9220 user interface software, using the Administrator account. By default, security is not enabled but can be defined and enabled by the Administrator once the system is installed See Figure 4.1.

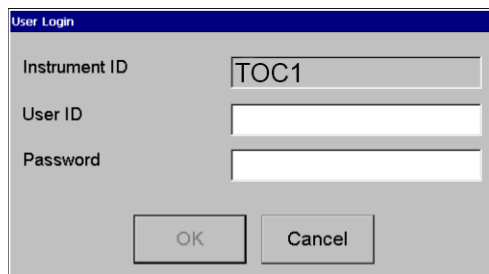

Figure 4.1 User Login Screen

4.2 User Interface Layout

Once logged in, the main 9220 user interface will appear. The 9220 user interface is organized into three main sections: the Menu Bar and the Status Bar (which appear on every screen), and the Menu-Specific Information (which varies by screen). See Figure 4.2.

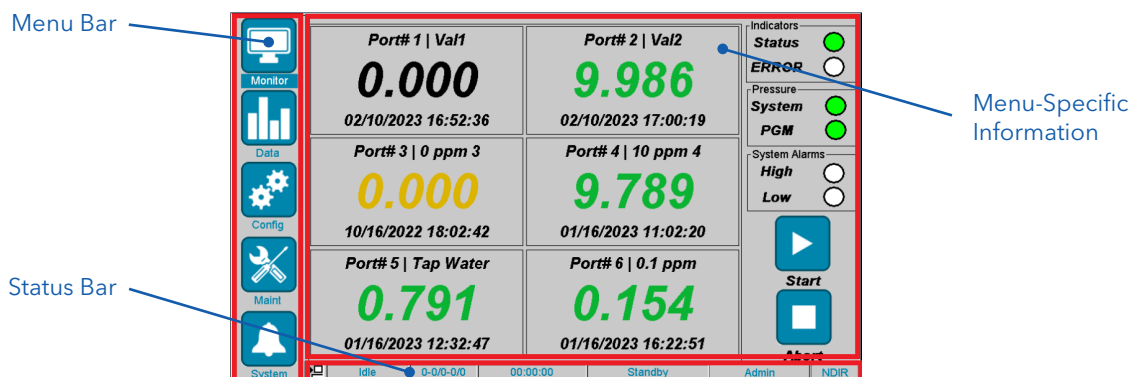

Figure 4.2 Monitor Screen

Menu Bar

The Menu Bar presents the five primary menu icons, which appear in a column down the left side of the screen. These menus allow the operator to view data, modify system settings, adjust analysis settings, modify data ranges, configure alarm outputs, and perform system maintenance.

To access a menu screen, press on the icon for that menu. Some menus, such as Configuration and Maintenance, contain additional icons to get to more screens. See **Table 4.1** for a complete menu structure for the 9220 User Interface.





Icon	Menu	Features	Description
	Monitor	<ul style="list-style-type: none"> - Data Panel (all channels) - System Status - Start/Abort commands - Switch User - NDIR Graph 	Accesses real-time conditions, including the latest result data for all sample channels, status, error, and alarm indicators, as well as the run state and time remaining in the current sample.
	Data	<ul style="list-style-type: none"> - Result Table (all channels combined) - Trend Graph (all channels combined) - Calibration Data 	Provides the operator with chronologically sorted data from the most recent samples processed for all sample channels. Also provides a summary of the current instrument calibration.
	Configuration	<ul style="list-style-type: none"> - Sequence - Method Settings - Sample Intro - System Configuration - ModBus Settings - Analog Output - Alarm Settings - Set Date/Time 	Defines various instrument configuration parameters. See details for each screen later in this chapter.
	Maintenance	<ul style="list-style-type: none"> - System Diagnostics - Data Storage - Run Log - Run Status - Manual Controls - CO₂ Detector - S/W Upgrades - Exit 	Accesses maintenance functions and manually controls hardware to aid in troubleshooting and tuning performance. See details for each screen later in this chapter.
	Alarms	<ul style="list-style-type: none"> - Reset alarms. - Clear Log 	Displays the most recent alarm conditions that the 9220 instrument has encountered. Allows the operator to clear any alarm condition, including external alarms and relays.

Table 4.1 Menu Bar

Status Bar Indicators

The status bar indicators at the bottom of the screen provide a quick visual representation of aspects of the 0220's condition and current activity (Figure 4.3). This bar shows the analyzer's current run status, port number and sample number, the time remaining in the current sample, processing states, and the Run / Edit toggle button.

Refer to Table 4.2 for status bar indicator icons and descriptions.



Figure 4.3 Status Bar Indicators







Indicator Icon	Indicator Meaning	Description
	Run Status	Displays the current run status. <ul style="list-style-type: none"> • Idle, Running, Aborted, Paused
	Sample Number	Displays the following information: <i>Port - Sample(x/y) - Rep(x/y)</i> <ul style="list-style-type: none"> • Port number (1-6) being sampled • Sample number (Current / Total), as defined in the sequence screen • Replicate number (Current / Total), as defined in the method screen
	Time Remaining (Hr:Min:Sec)	Displays the time remaining in processing all replicates of the current sample (Hours:Minutes:Seconds).
	Current State	Displays the current state : <ul style="list-style-type: none"> • Power Up, Standby, Prime Sample, Load Sample, Load Acid, TIC Removal, Transfer Sample and Reagents, TOC React, TOC Detect, End, Drain, etc. • "Power Up" state indicates that the system is running its normal preparation activities following a Power ON condition. This state lasts about five minutes. • "Standby" state indicates that the system is ready to process samples. See details about the "Start" button to begin sample processing.
	Current User (button)	This button displays the current user's name (Admin or Operator). It also can be clicked to display a popup screen to change users.
	NDIR Graph (button)	This button can be clicked to show the NDIR signal graph. This is a shortcut to the same graph shown on the Maint->Manual Controls->Detector page.

Table 4.2 Status Bar Indicators

4.3 Monitor Screen

The monitor screen serves as the primary operator screen for monitoring the sample analysis concentrations for all samples being analyzed by the 9220 system (Figure 4.4).

This screen provides three main functional panels:

- Data Panel
- Indicator Panel
- Action Panel

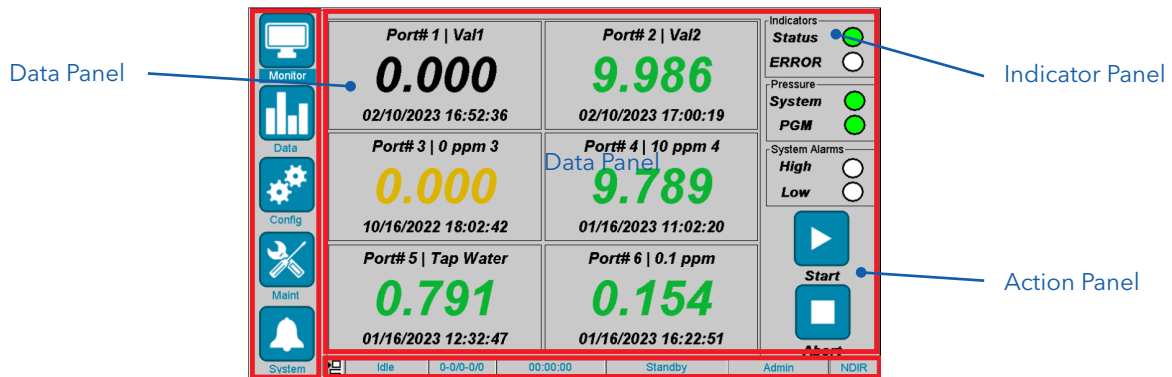

Figure 4.4 Monitor Screen

Monitor - Data Panel

The monitor screen displays a large data panel that provides a quick look at the most recent data for all 6 samples defined in the 9220 system.

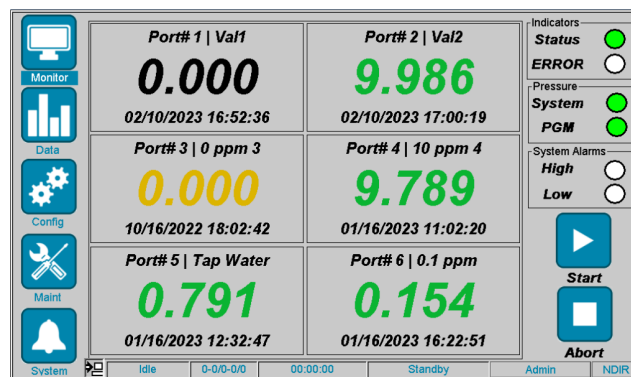

Figure 4.5 Monitor Screen - Data Panel

Monitor - Data Panel

Each sample, or port, has its own data panel containing the following information:

- **Port # and Sample Name**
 - Shown at the top of each panel.
 - Also, if the port is currently involved in an auto-calibration or auto-validation, that label is also shown.

- **Date/Time of Analysis**
 - Shown at the bottom of each panel.
 - This is time for the latest sample value (shown).

- **TOC PPM Value**
 - Shown in large print in the middle of each panel.
 - This is the concentration value of the last sample analyzed.
 - The value's color is based on how the result compares to the operator-specified alarm limits for that channel, as defined on the [Config → Alarm Settings → Relay2 - Sample Alarms](#) page. See Table 4.3.

Data Display Color	Description
Dash ("-")	Indicates this port has no recent data results
Black	Indicates no range is defined for this sample
Green	Indicates the data value is "in range"
Yellow	Indicates the data value is in the "low warning" or "high warning" range
Red	Indicates the data value is in the "low error" or "high error" range

Table 4.3 Monitor - Data Panel: Display Color Meanings

In addition to the most recent data display in the panel, the operator can select any of the 6 data panels and access more data for that port/channel.

Each panel contains sub-screens presenting data specific to only that port/channel:

- Data Table
- Data Trend Graph
- Data Statistics

Monitor - Data Panel - Data Table

The Data Table displays the latest sample results, in chronological order, for the port/channel panel that was selected. The scrollable list of data results shows 10 values at a time, with the most recent data at the top of the list. The data includes the sample number, date/time of analysis, sample ID (name), and sample concentration (PPM). See Figure 4.6.

NOTE: Sample results on these data panel screens and replicate screens update after each replicate..

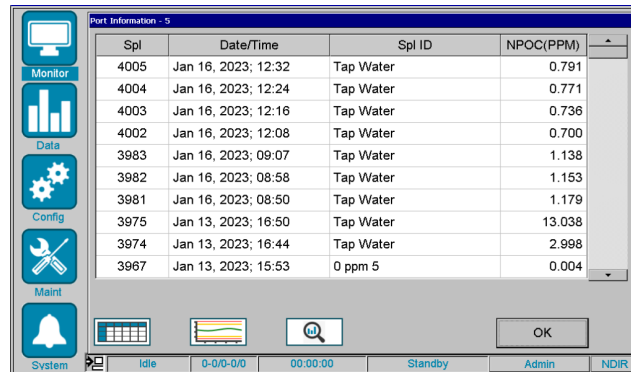

Spl	Date/Time	Spl ID	NPOC(PPM)
4005	Jan 16, 2023; 12:32	Tap Water	0.791
4004	Jan 16, 2023; 12:24	Tap Water	0.771
4003	Jan 16, 2023; 12:16	Tap Water	0.736
4002	Jan 16, 2023; 12:08	Tap Water	0.700
3983	Jan 16, 2023; 09:07	Tap Water	1.138
3982	Jan 16, 2023; 08:58	Tap Water	1.153
3981	Jan 16, 2023; 08:50	Tap Water	1.179
3975	Jan 13, 2023; 16:50	Tap Water	13.038
3974	Jan 13, 2023; 16:44	Tap Water	2.998
3967	Jan 13, 2023; 15:53	0 ppm 5	0.004

Figure 4.6 Monitor Screen - Data Panel - Data Table

Monitor - Data Panel - Data Table - Replicate Results

To view the individual replicates and statistics, double-click on the sample of interest in the data table and the sample results page pop-up will appear. This screen shows the results for each replicate (area and Conc), standard deviation, and %RSD for all of the replicates. See Figure 4.6a

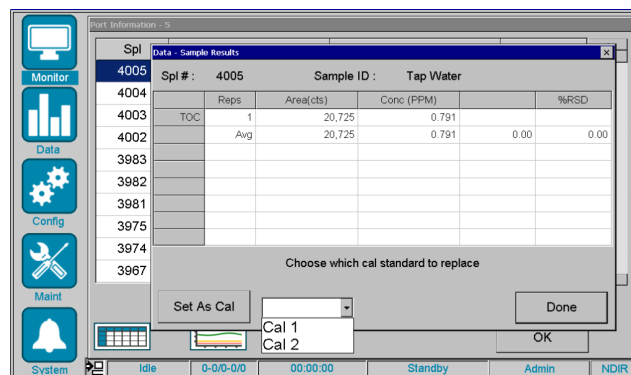

Spl	Area(cts)	Conc (PPM)	%RSD
4004			
4003	20.725	0.791	
4002	20.725	0.791	0.00
3983			
3982			
3981			
3975			
3974			
3967			

Figure 4.6a Monitor Screen - Data Panel - Data Table - Replicate Results

Another feature of this screen allows the operator to update the calibration by selecting "Cal 1" (low) or "Cal2" (high) and clicking the "Set as Cal" button. See Figure 4.6b.

This will automatically update the calibration details, RF, and offset for immediate use by upcoming samples. This saves the operator the step of running a CAL type sample.



Figure 4.6b Monitor Screen - Data Panel - Data Table - Replicate Results - Set as Cal 1 or 2

Monitor - Data Panel - Data Trend Graph

The Data Trend Graph displays a graphical representation of the same data that is currently selected in the data table display, as these two screens are linked. A scrollbar is provided to move through all the list's data. See Figure 4.7.

In addition to the concentration data trend line for the samples, the operator-defined low-warning and high-warning limit lines are drawn as yellow horizontal lines, and the low-error and high-error limit lines are drawn as red horizontal lines. These reference lines allow the operator to easily see how the sample results are trending relative to the limits defined on the **Config** → **Alarm Settings** → **Relay2 - Sample Alarms** page. See the description of that page later in this chapter.

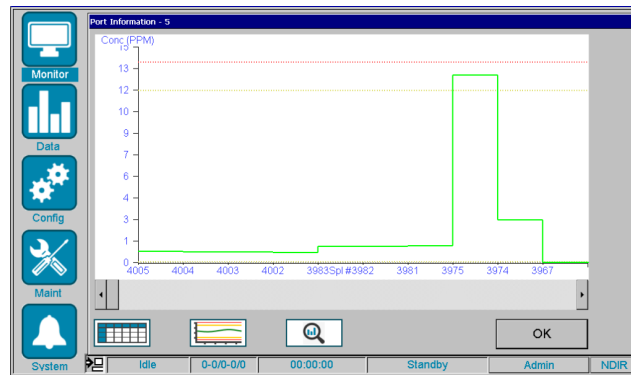

Figure 4.7 Monitor Screen - Data Panel - Data Trend Graph

Monitor - Data Panel - Data Statistics

The Data Statistics page shows various statistical values for the data analyzed for this port/channel. The statistics are calculated and displayed separately for the 10 most recent samples and for ALL of the samples in the data table. See Figure 4.8.

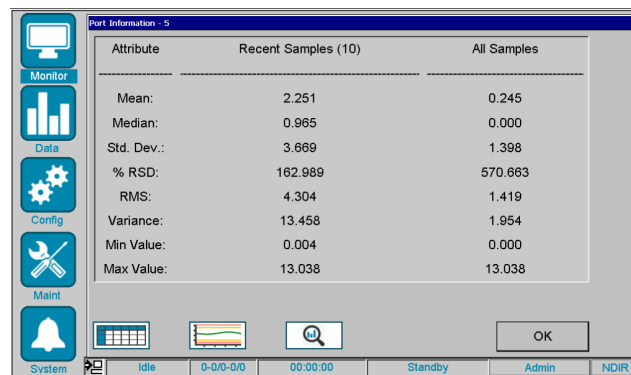

Figure 4.8 Monitor Screen - Data Panel - Data Statistics

Monitor - Action Panel

The Monitor section provides two action icons and several status indicators arrayed along the bottom of the screen. See Table 4.4 for these two action icons and their descriptions



Action Icons	Description
	Immediately initiates the current sequence processing based on the sampling sequence defined in the config - sequence screen.
	Immediately terminates any sample processing step, drains the syringe and TOC reaction vessel, and returns the instrument to the standby state.

Table 4.4 Monitor Screen - Data Panel - Data Statistics

Monitor - Indicator Panale

The Status Monitor screen provides visual indications of the analyzer's current status and its progress in analyzing samples. See Table 4.5.



Action Icons	Description
	<p>These system indicators provide a quick view of:</p> <ul style="list-style-type: none"> • System Status (Green = Okay; Red = Error) • System Error (White = No Error; Red = Error)
	<p>These pressure indicators provide a quick view of the two gas pressure readings.</p> <ul style="list-style-type: none"> • One is for the system pressure generated by the EPC to control the main carrier gas flow to the NDIR detector. • The other is the PGM gas pressure (maintained in the gas canister scrubber) which feeds CO₂-free air to the entire 9220 system. • Green = No error; operating in Normal range • Red = Error; pressure is low or high of rang <p>NOTE: In the event of either pressure error, the 9220 system may terminate the sequence and return to idle state if the pressure issue persists.</p> <p>NOTE: The actual system and PGM pressure values can be found on the <i>Maint</i> → <i>Manual Controls</i> → <i>Pres/Temp</i> screen.</p>
	<p>These alarm indicators show if any of the active channels (1 - 6) in the currently running sequence have a high or low alarm level status.</p> <ul style="list-style-type: none"> • High Alarm (White = No Error; Yellow = High Warning; Red = High Error) • Low Alarm (White = No Error; Yellow = Low Warning; Red = Low Error) <p>NOTE: The color of the readings on the monitor data panels will show which channel(s) has an error.</p>

Table 4.5 Monitor - Indicator Panel

4.4 Data Screen

The Data Menu provides screens for viewing the sample results, as well as calibration results data. Press the data icon and the data table screen will be displayed.

NOTE: Once another data screen has been viewed (either the trend or calibration screen), the system will automatically return to the last data screen viewed upon leaving and returning to the data screen.

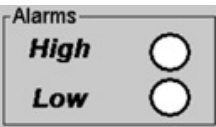
Data Table Screen

The Data Table screen shows the combined, chronological results for **ALL samples (all Ports)** that have been processed since the last time the 9220's data results memory was archived and cleared. Data shown includes port number, sample number, date/time of analysis, sample ID, and computed sample concentrations for NPOC (in PPM).

NOTE: The data table can display up to 9999 samples before the sample numbers are reset to 1 and repeated.

NOTE: See the Maint->Data Storage screen for further information about archiving and clearing the 9220's onboard data results memory.

Press the Data >Table icon  to view this screen (Figure 4.9).

This data table view allows the operator to see a table of 10 sample results at a time. By default, these are the 10 most recent sample data results. However, the data displayed on the table can be navigated to display earlier or more recent results using the scrollbar on the right side of the table.

NOTE: Sample results are only updated for the current sample, upon completion of the last replicate of that sample.

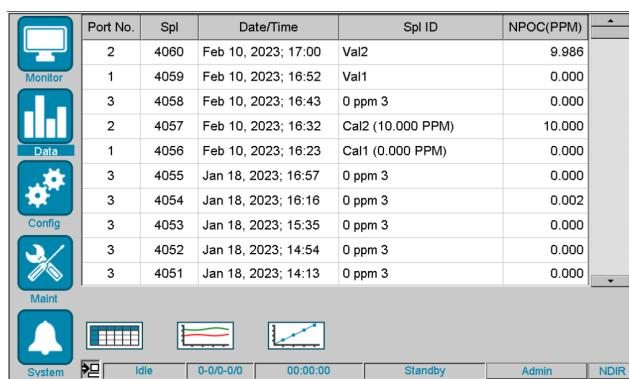

Port No.	Spl	Date/Time	Spl ID	NPOC(PPM)
2	4060	Feb 10, 2023; 17:00	Val2	9.986
1	4059	Feb 10, 2023; 16:52	Val1	0.000
3	4058	Feb 10, 2023; 16:43	0 ppm 3	0.000
2	4057	Feb 10, 2023; 16:32	Cal2 (10.000 PPM)	10.000
1	4056	Feb 10, 2023; 16:23	Cal1 (0.000 PPM)	0.000
3	4055	Jan 18, 2023; 16:57	0 ppm 3	0.000
3	4054	Jan 18, 2023; 16:16	0 ppm 3	0.002
3	4053	Jan 18, 2023; 15:35	0 ppm 3	0.000
3	4052	Jan 18, 2023; 14:54	0 ppm 3	0.000
3	4051	Jan 18, 2023; 14:13	0 ppm 3	0.000

Figure 4.9 Data Screen - Data Table

Viewing Sample Replicate Details

To view the individual sample replicate results, including area, concentration, standard deviation, and % relative standard deviation (%RSD), double-click any sample row in the sample table to view the Data → Sample Results screen (Figure 4.9a).

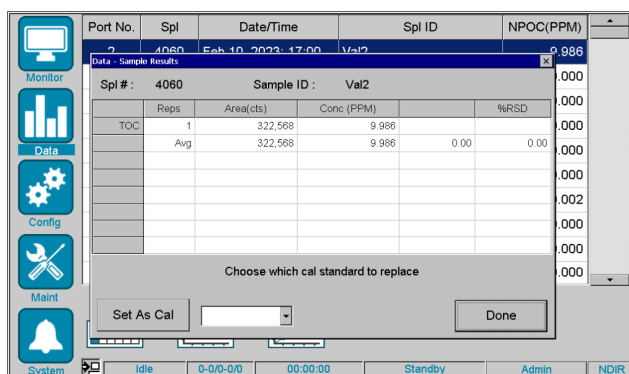

Repls	Area(cts)	Conc (PPM)	%RSD
1	322,568	9.986	0.000
Avg	322,568	9.986	0.000

Choose which cal standard to replace

Set As Cal Done

Figure 4.9a Data Screen - Data Table - Replicate Results

In addition to displaying the detailed sample results, this screen also allows the operator to set the currently viewed value with either a Cal 1 (low) or Cal 2 (high) value. This can be used as an on-the-fly means of calibrating the system without having to change the sequence to add calibration samples (Figure 4.9b).



Figure 4.9b Data Screen - Data Table - Replicate Results - Set as Cal

Set as Cal 1 (Low)

The Set as Cal 1 button will automatically assign the average area value of the sample being viewed as the Cal 1 (low) value in the current calibration, based on the concentration level specified in the method settings screen. The updated calibration mode is automatically based on the analysis mode of the sample.

Upon clicking this button, a confirmation message will appear (Figure 4.10).

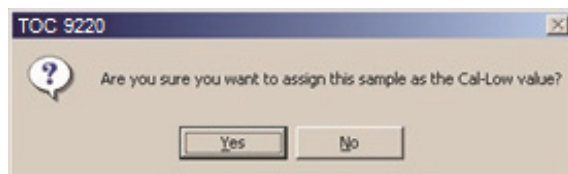

Figure 4.10 Set as Cal 1 (low) or Set as Cal 2 (high) Confirmation Message

Once approved by the operator, the following update message will appear (Figure 4.11).

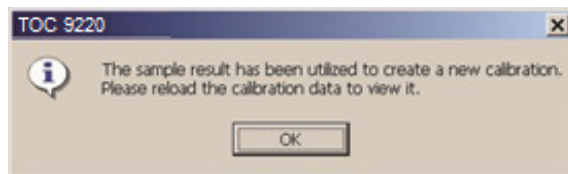

Figure 4.11 Set as Cal 1 (low) or Set as Cal 2 (high) Update Message

While the calibration data is automatically updated internally within the system memory and will be used for all sample calculations effective immediately, the **Data** → **Calibration** table does NOT update automatically. Thus, this confirmation message is instructing the operator to reload the calibration information on the screen manually. This is done by navigating to the **Data** → **Calibration** table and clicking the mode toggle button three times until the display returns to the current calibration mode. See the **Data** → **Calibration** table section for more details on this screen.

Set as Cal 2 (High)

The Set as Cal 2 button will automatically assign the Average Area value of the sample being viewed as the Cal 2 (high) value in the current calibration, based on the concentration level specified in the Method Settings screen. The updated calibration mode is automatically based on the analysis mode of the sample.

Otherwise, this feature functions the same as the Set as Cal 1 (low) operation. Please refer to that section for more details.

Data-Trend Screen

The Data Trend screen functions the same as the Monitor-Data Panel-Trend Display, except it shows the data results from ALL samples and channels chronologically. Please refer to that section for complete details on the function of this screen.

Press the Data → Trend button  to view this screen (Figure 4.12).

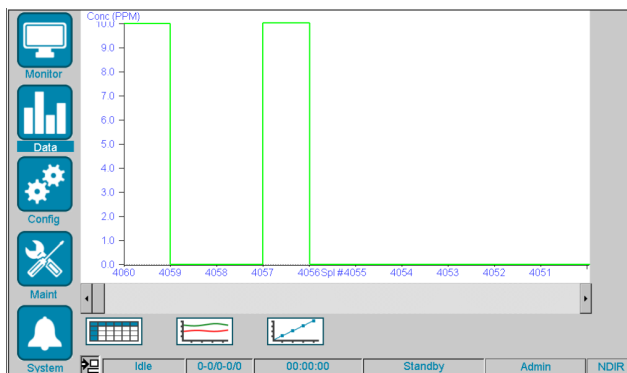

Figure 4.12 Data Screen - Data Trend Graph

Data-Calib Screen

The Data Calibration screen provides details on the active calibration for the current analysis mode.

Press the Data → Calib button  to view this screen.

Data-Calib Screen - Summary

The calibration curve data values consist of the response factor (RF) or slope, the Y-intercept (Offset), and the correlation coefficient (R^2). The curve fit defaults to Linear (unweighted). The date of the most recent update to the calibration is also shown (Figure 4.13).

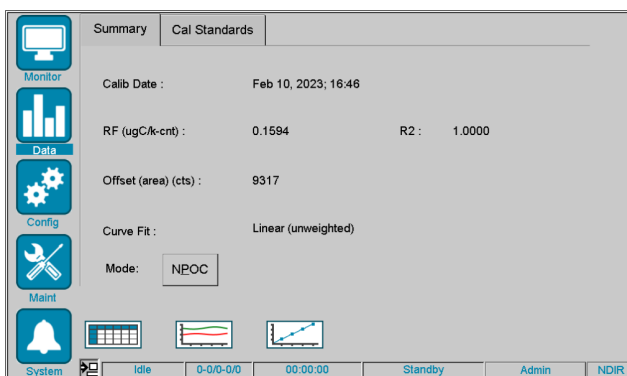

Figure 4.13 Data Screen - Calibration - Summary

The RF or slope indicates the response of the system in terms of mass-of-carbon per area counts measured. The units for the RF are in micrograms of carbon per 1000 counts ($\mu\text{gC/k-cnts}$).

The Offset is the Y-intercept value (in area counts) of the line of best fit found when calculating the RF. If a 0 ppm standard is the Cal-Low value, then the Offset will be equal to the average of the 0 ppm area counts, as shown in the calibration table. Otherwise, the Offset is calculated based on where the RF intersects the Y-axis.

The R^2 represents the goodness-of-fit of the calibration curve, where 1.000 represents a perfect fit. Given a simple, two-point calibration curve, the R^2 value is typically very good (i.e., greater than 0.999), unless the replicates of one of the calibration points are not very good (i.e., a high %RSD). If only one replicate is run for each standard, the R^2 will automatically be 1.000.

The date of the most recent calibration, or update to the calibration, is shown on the screen. The value is updated whenever a change is made to the calibration, either by running a calibration standard, using the Set as Cal-Low, or Set as Cal-High features.

Data-Calib Screen - Cal Standards Table

The calibration standards table shows the list of sample values used to create the calibration curve. This table is updated with the calibration data for that mode, showing the calibration standard concentrations, the number of replicates analyzed, the average Area Count results for the replicates of that standard, as well as the Relative Standard Deviation (RSD) for those replicates.

During the process of calibrating, the Data Calibration screen updates as new data becomes available. All computed values for the calibration curve become updated and refreshed in real-time—an example of updating the calibration high standard value using the Set as Cal 2 (high) is shown in Figure 4.14.

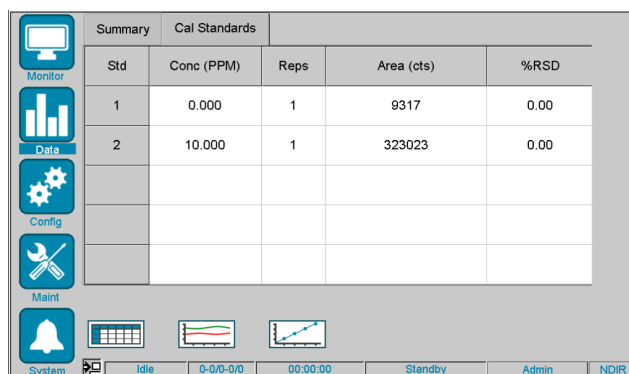

Std	Conc (PPM)	Reps	Area (cts)	%RSD
1	0.000	1	9317	0.00
2	10.000	1	323023	0.00

Figure 4.14 Updated Data-Calib Screen Using the Set as Cal 2 (high) Feature

NOTE: Only one “active” calibration is stored for the analysis mode regardless of the method settings used to generate those curves. For best (and most accurate) results, be sure that the samples being analyzed are using the same method settings as those used to perform the calibration.

4.5 Configuration Screen

The Configuration menu provides access to several screens for managing the analyzer's various hardware and software configurations. These items are grouped into separate logical icons based on their purpose in the system. Press Config to view this screen (Figure 4.15).

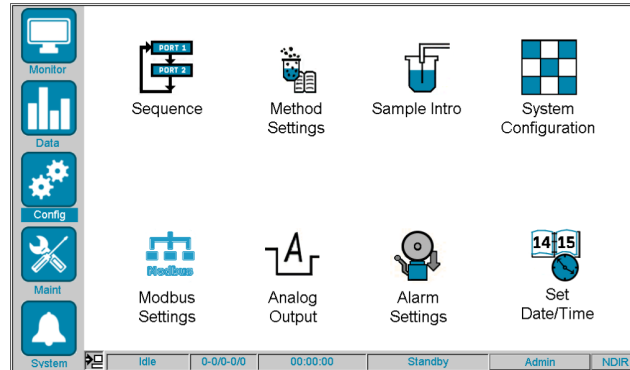

Figure 4.15 Configuration Screen

Sequence Screen

The Config → Sequence (Figure 4.16) screen allows the operator to define and modify the sampling sequence. A sequence must be defined, with at least one active port/sample, before the 9220 can process samples. Once the sequence is defined, the operator can begin sample processing by clicking the **Start** button on the monitor screen.

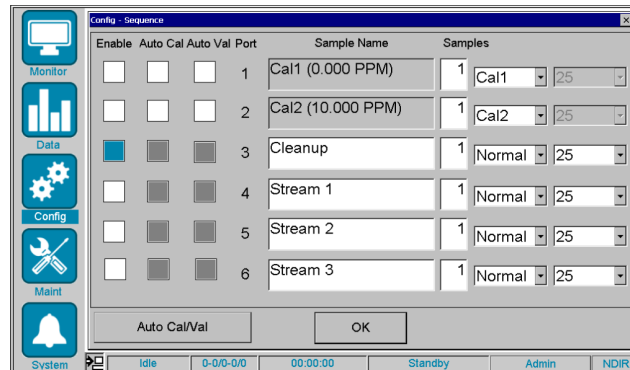

Figure 4.16 Config - Sequence Screen

In general, the sequence for the 9220 is programmed for continuous processing samples, where one or more ports must always be enabled for the system to process samples.

NOTE: If no ports are enabled, the sample processing sequence will terminate, and the system will return to the Standby state.



Item	Description
Enable	The Enable checkbox is used to indicate that a port is to be included (active) in the sequence. If a port is not enabled, it will not be sampled during the sequence.
Auto-Cal	The Auto-Cal checkbox determines if this sample is to follow the Auto-Cal rules, as defined in the Auto Cal/Val screen. See more about that section below. The sample type must be Cal for this feature to work.
Auto-Val	The Auto-Val checkbox determines if this sample is to follow the Auto-Val rules, as defined in the Auto Cal/Val screen. See more about that section below. The sample Type must be Val for this feature to work.
Port #	The port number is fixed, indicating ports 1 to 6. This corresponds to the port number on the Sample Port Selection Valve.
Sample Name	The Sample Name is the operator-specified name to describe the sample at that port (e.g. Influent, Filtered, Treated, Effluent, etc.)
# Samples	<p>This field specifies the number of times this sample is to be analyzed (consecutively) before moving to the next sample in the sequence. This field effectively multiplies the number of replicates specified in the method. For example, if the # reps in the method = 3 and the # samples for this port in the sequence = 2, then this port will be sampled 6 consecutive times before advancing to the next sample. The maximum number of samples is 99.</p> <p>NOTE: <i>If only one replicate of each port is desired per sequence cycle, then set the # reps in the method = 1 and the # samples in the sequence = 1.</i></p>
Sample Type	<p>The Sample Type determines how the sample on that port will be processed. Samples can be Calibration/Validation types (i.e., Cal/Val) or they can be Sample types.</p> <ul style="list-style-type: none"> • Cal/Val types <ul style="list-style-type: none"> ▫ Cal types include CAL1 through CAL5, since up to 5 calibration points can be defined for the method. ▫ Val types include VAL1 thru VAL5. • Sample types <ul style="list-style-type: none"> ▫ Normal samples are processed in the standard sequence processor order, with no priority. ▫ Priority samples will be sampled at the next available opportunity in the sequence. This is typically used for processing grab samples, or for promoting a sample port of interest in the event of a suspected change in concentration. <p>NOTE: <i>Once a Priority sample is processed, that port will return to Normal status for future processing.</i></p>
Range	The Range value specifies the expected concentration range (in PPM) for this sample port. The 9220 will automatically adjust the sample processing to handle higher concentration ranges. The choices are: 0-25PPM, 0-250PPM, 0-2500PPM, and 0-25000PPM

Table 4.6 Config - Sequence Screen

Sequence Screen - Sample Type

The available options for Sample Type vary depending on the port number and the number of calibration points defined in the **Method** → **Calibration** page. The reason for this is to help simplify and standardize how the port definitions are specified.

Since the method definition must always include at least 2 calibration points (low and high to define the operating range of the method), ports 1 and 2 are always defined as either Cal or Val types, where Port 1 = CAL1/VAL1 and Port 2 = CAL2/VAL2.

If more calibration points are defined in the method (up to a max of 5), then ports 3, 4, and 5 will become available to select the type as CAL3/VAL3, CAL4/VAL4, and CAL5/VAL5, respectively.

For any remaining ports that are not defined as calibration points in the method, the options for type are **Normal** or **Priority**. By default, these ports are pre-defined to be normal priority sampling ports. That means that each of these ports has the same priority as the other, so they will be performed in sequential order starting from port 1.

Normal samples are treated as “continuous” processing samples. That is, they are never automatically deactivated and, thus, will run continuously until the operator manually changes or cancels the sequence. Except for CAL/VAL samples, sample ports that are to be routinely processed should be defined as normal.

Priority samples (which include Priority, CALx, and VALx) are considered “temporary” by the software. If any of the priority type processing modes are selected by the operator, then that port will be sampled immediately upon the conclusion of all replicates of the current sample of the current port. However, upon conclusion of a priority type sample, the software will deselect that sample automatically so that the processing of normal priority samples can be resumed without user input.

Priority samples are typically used for “grab” samples that may need to be run on an “as soon as possible” basis. The concentration results are calculated in exactly the same way as normal samples.

The **VALx** sample types are used to manually validate the current calibration of the instrument. These results are calculated the same as normal samples, except that the concentration is then automatically compared against the expected concentration for that standard. See the **Method** → **Validation** screen description below for more details.

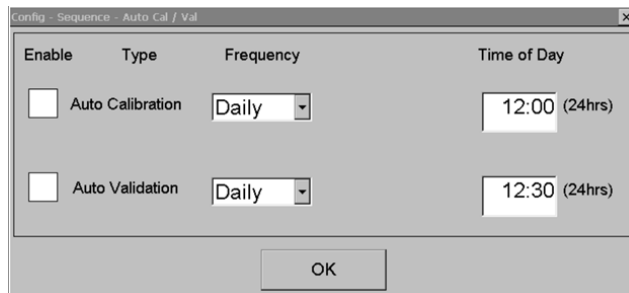

Enable	Type	Frequency	Time of Day
<input type="checkbox"/>	Auto Calibration	Daily	12:00 (24hrs)
<input type="checkbox"/>	Auto Validation	Daily	12:30 (24hrs)

OK

Figure 4.17a Config - Sequence - Auto Cal/Val Settings

Method Settings Screen

The **Method Settings** screen allows the operator to specify the individual settings that control the sample analysis. This screen is divided into three sections:

- Basic Method
- Calibration
- Validation

The 9220 system uses only one method to analyze all samples in the defined sequence. Once the sequence is started, some parameters cannot be changed in the Method Settings screen, until the sequence is terminated. However, other Method Settings parameters can be changed, as needed, while the sequence is running.

NOTE: *Changing certain method parameters, such as volumes and times, can significantly change the performance of the analyzer. If significant changes are made, it is recommended that the analyzer be re-calibrated to account for these changes in the method.*

Method Settings Screen - Basic Method Tab

The **Basic Method** tab includes settings for the analysis mode, sample and reagent volumes, analysis time, and temperatures, and calibration range (Figure 4.17).

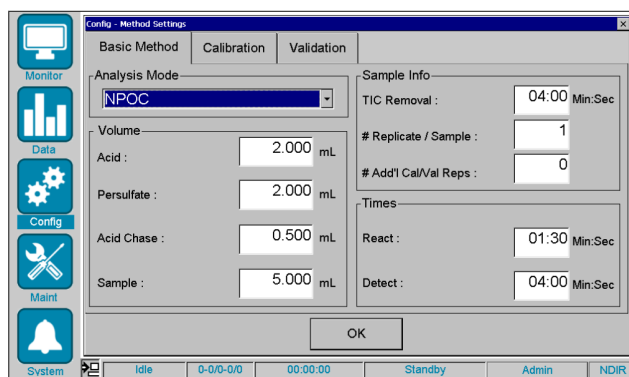

Figure 4.17 Config - Method Settings - Basic Method Screen

The **Analysis Mode** specifies the desired analysis to be performed on each sample and any calibrations that might be performed. Currently, the only available choice is NPOC.

The **Acid Volume (mL)** field specifies the volume of acid to be injected for TIC removal of each sample replicate. The maximum acid volume that can be specified in the software is 25mL. However, the actual maximum that can be injected is much less, due again to the fact that the total syringe volume is 25mL and that sample volume and headspace volume must be accounted for as part of the total volume. It is a good practice only to use as much acid as is required by the sample matrix to fully oxidize the TIC. Using too little will result in incomplete TIC conversion. Using too much will waste reagent and reduce the available amount of sample volume that can be specified. The typical acid volume should be less than 5mL.

The **Acid Chase (mL)** field specifies the volume of acid used to “chase” the sample pathway (from syringe to reactor) to reduce sample-to-sample carryover. After the sample has been transferred from the reactor, the specified volume of acid is pulled into the syringe, then transferred to the reactor, thus sweeping the pathway of any residual sample droplets and ensuring a complete transfer of the entire sample. The maximum volume is 5 mL.

The **Persulfate Volume (mL)** field specifies the volume of persulfate that is injected directly into the TC Reactor for each sample replicate. The persulfate is used in conjunction with heat to react with the sample to release the CO₂. The maximum volume is 25 mL.

The **Sample Volume (mL)** field specifies the volume of sample to be injected for the analysis of each sample replicate. The maximum sample volume that can be specified in the software is 10mL. However, the actual maximum that can be used is somewhat less, due to the fact that the total syringe volume is 25mL and that acid reagent volume and headspace volume must be accounted for as part of the total volume in the TC reactor.

NOTE: The typical sample volume is 1.0 to 5.0mL, with a typical acid reagent volume of 0.5 to 2.5mL (for a total of 1.5 - 7.5mL).

NOTE: Also, the sample volume must be adjusted according to the expected concentration of the samples to be analyzed. Because the working linear range of the 9220's NDIR detector is 250ug of Carbon (µgC), the following limitations apply: $\text{Sample_Concentration (in PPM)} * \text{Sample_Volume (in mL)} \leq 250 \mu\text{gC}$

For example:

- $20\text{ppm} * 10\text{mL} = 200\mu\text{gC}$
NOTE: This would be within the linear range of the detector.
- $100\text{ppm} * 3\text{mL} = 300\mu\text{gC}$
NOTE: This would NOT be within the linear range of the detector.

TIC Removal time specifies the minimum time to remove the TIC from the sample once the acid has been drawn into the syringe during the sample injection process. The maximum time allowed is 30 minutes (30:00), but typical samples with low TIC content should only require 2 or 3 minutes of TIC removal time.

NOTE: When analyzing samples using NPOC-Only mode, the system may begin the TIC removal process on the next sample (or replicate) while it still reacts and detects NPOC for the current sample, depending on system settings. In such a case, TIC removal time will be the minimum amount of time spent in the TIC removal process, but it may extend much longer depending on how long the current sample takes to complete the TOC React and TOC Detect states.

The **# Replicate / Sample** field specifies the number of replicates of each sample to be analyzed for statistical calculation purposes. This is particularly useful for calibration standards, where the same exact sample can be analyzed multiple times. However, this may not be as useful for process samples, since the actual sample is flowing and varying constantly, in which case only one replicate per sample may be required. The maximum number of replicates is 15.

The **# Add'l Cal Replicates** field allows the operator to specify several possible additional replicates that could be analyzed when processing calibration standards. If this number of replicates is greater than zero, then this allows the system to process that number or replicates, and discard those initial replicate values, before analyzing the remaining replicates that will be used in the calibration statistics. This is a useful tool when trying to reduce any carryover effects during the calibration process. The maximum number of additional replicates is 15.

The **React Time** field specifies the amount of time the system will perform the React state when NPOC-Only mode is selected as the Analysis Mode. During the React state, which occurs immediately after TIC Removal and sample transfer to the reactor, the system will heat the sample/acid/persulfate mixture to convert the TOC in the sample to CO₂ in preparation for the Detect state that follows. The maximum React time is 30 minutes.

The **Detect Time** field specifies the maximum amount of time the system will perform the Detect state when NPOC-Only mode is selected as the Analysis Mode. During the Detect state, the system will continue to circulate the sample/reagent mixture but will now flow the carrier gas into the reactor. The system will also adjust the valve positions to direct the carrier/CO₂ gas mixture toward the NDIR detector for analysis. This time is a fixed window during which the entire sample peak must occur. If this time is set too short, the peak will be cut off too soon, resulting in incomplete recovery.

NOTE: If the software detects that the "end of peak" has occurred prior to reaching this maximum detect time, then it will automatically terminate the Detect state. The maximum detect time is 30 minutes

Method Settings Screen - Calibrations Tab

The Calibration tab includes settings for the Calibration Standards, Curve Fit, and Pass/Fail criteria (Figure 4.18).

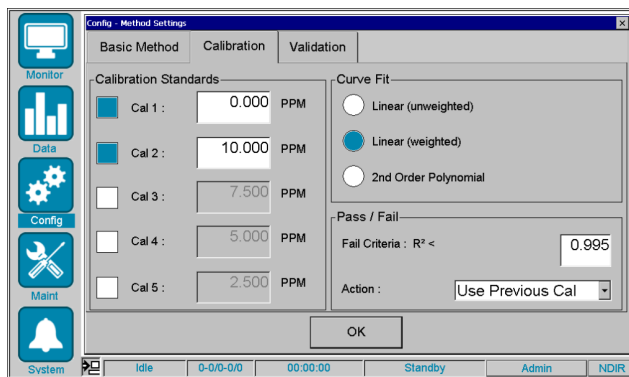

Figure 4.18 Config - Method Settings - Calibration Screen

The **CAL1** through **CAL5** concentration fields are used to define the target range of analysis to be used when processing samples. This range should be set appropriately to "bracket" to the expected sample range. Setting the range either too small or too large could result in reduced accuracy when calculating sample recovery.

To enable the calibration point in the method, activate the checkbox next to the CAL points to be enabled.

NOTE: Clicking the Enable checkbox for any calibration point does not automatically mean the CAL will be analyzed in the sequence. The sequence screen will have to be updated to specify that the CAL point is to be included in the sequence.

The **CAL1** concentration field defines the low-end concentration point in the calibration. If using DI water as the CAL1 (low) value, then enter 0 PPM for the Cal Low standard concentration, since the other CAL standards should be made with that same DI water, and thus the “relative” concentration of the DI water is zero. The maximum value for the CAL1 concentration is 250 ppm.

NOTE: Each successive calibration point must be a greater concentration than the previous one. That is, CAL2 must be greater than CAL1, CAL3 must be greater than CAL2, and so on.

NOTE: The DI water used in the calibration process must have a minimal amount of carbon relative to the expected sample concentration (i.e., less than 200 ppb). Otherwise, this can cause low-concentration samples to be misreported.

The highest **CALx** enabled in the calibration (e.g., CAL5) defines the high-end concentration point in the calibration. This value should be somewhat above the expected maximum concentration of the samples to be analyzed. However, it should not be set too high, as this can cause errors in the recovery calculations of samples based on slight errors in the calibration response factor (RF). The maximum concentration value for the highest CALx is 250 ppm. The minimum value for Cal 2 is 1 ppm.

The **Curve Fit** selection determines how the calibration fit line will be calculated. The available options are:

- **Linear (unweighted)**
 - This is the default selection, as it typically best represents the calibration curve when only 2 calibration concentrations are used.
- **Linear (weighted)**
 - When 3 or more calibration concentrations are used, this option may produce a better overall curve fit, if the unweighted curve fit is not drawing the calibration curve near the CAL1 point. This may indicate some nonlinearity in the response.
- **2nd Order Polynomial**
 - This fit is used when 4 or 5 calibration concentrations are used, and there seems to be some slight nonlinearity causing the Linear Weighted option not to be the best choice.

The **Pass/Fail Criteria** set the R2 threshold for passing or failing the calculated calibration curve fit, and determine what action is to be taken in the event the calibration fails. The choices of failure actions include:

- **Recalibrate**
 - The entire calibration (including all standards) will be re-run and then re-calculated.
- **Use Previous Cal**
 - The system will revert to the previous version of the calibration, prior to the latest change that caused the failed calibration.

Method Settings Screen - Validation Tab

The Validation tab includes settings to enable the validation for standards and set the Pass/Fail criteria (Figure 4.19).

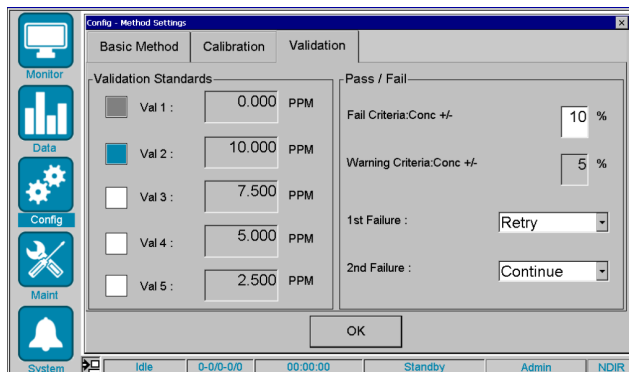

Figure 4.19 Config - Method Settings - Validation Tab

The VAL1 through VAL5 concentration fields are carried over automatically from the calibration tab and are not changeable. To enable validation for any concentration, click on the enable box for that port/concentration. Once enabled, these VAL ports can be selected in the sequence screen for analysis.

NOTE: Clicking the Enable checkbox for any validation point does not automatically mean the VAL will be analyzed in the sequence. The sequence screen will have to be updated to specify that the VAL point is to be included in the sequence.

The Pass/Fail Criteria set the fail-level and warning-level concentration threshold percentage for passing or failing the validation point. If either a warning or error level is determined, then the analog output alarm may be triggered, if enabled in that analog output screen.

In addition to the fail and warning threshold, this screen also determines what action is to be taken in the event of a validation failure. The choices of failure actions for the first failure include:

- **Retry**
 - The validation sample is re-analyzed and re-evaluated for pass/fail.
- **Continue**
 - Post the results of the validation sample and continue the sequence.

The choices of failure actions for the second failure include:

- **Continue**
 - Post the results of the validation sample and continue the sequence.
- **Recalibrate**
 - Post the results of the validation sample and recalibrate the method.

Sample Introduction Screen

The Sample Introduction screen consists of three tabs that define the basic sample handling settings for the 9220 device, including the Prime settings, Sample Loop Timing settings, and Starts and Intervals settings. Click the Sample Intro icon to view this screen.

Prime Tab

The Prime tab is used to define the various prime volumes (in mL) and number of primes for sample and replicate priming, as well as reagent priming (Figure 4.20).

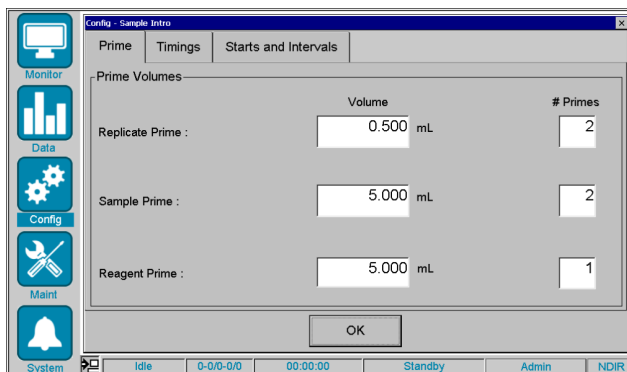

Figure 4.20 Config - Sample Intro - Prime Tab

The **Sample Prime Volume** field specifies the volume of sample drawn in before the first replicate of each sample is processed. This volume should be slightly greater than the total volume of the sample inlet tube (measured from the sample container to the syringe) to ensure that fresh sample is drawn into the analyzer for each sample. The operator can test this volume by using the Prime Sample macro on the **Maint** → **Manual Controls** → **Controls** screen, and then return to this screen to make further adjustments. The maximum value is 25mL.

The **Replicate Prime Volume** field specifies the volume of sample drawn in before each subsequent replicate (after the first replicate) of each sample is processed. This volume can be considerably less than the sample prime when the sample is being drawn from an unchanging sample concentration, such as a standard vial or other type of non-flowing sample container. The maximum value is 25mL.

The **Reagent Prime Volume** field specifies the volume of acid and persulfate drawn toward the syringe at the beginning of each sequence. This volume should be slightly greater than the volume of the reagent inlet tube to ensure that fresh reagent is drawn into the analyzer before a sequence is started. The operator can test this volume by using the Prime Acid or Prime Persulfate macro on the **Maint** → **Manual Controls** → **Control** screen, and then return to this screen to make further adjustments. The maximum value is 25mL.

A separate **Number of Primes** field is available for each of these specific prime entries. These values are used to perform multiple priming operations, using the volume specified. The minimum value is 1 and the maximum value is 10.

NOTE: *The most important of these are typically the Sample Prime Volume and Number of Prime fields. Utilizing multiple sample primes will significantly reduce the possibility of sample-to-sample carryover, since each prime will rinse and flush the sample inlet tubing as well as the syringe body and plunger assemblies.*

Timings Tab

The **Timings** tab is used to define the times used for flushing and settling the external fill-and-spill sample loops when the optional sample valves are installed (Figure 4.21).

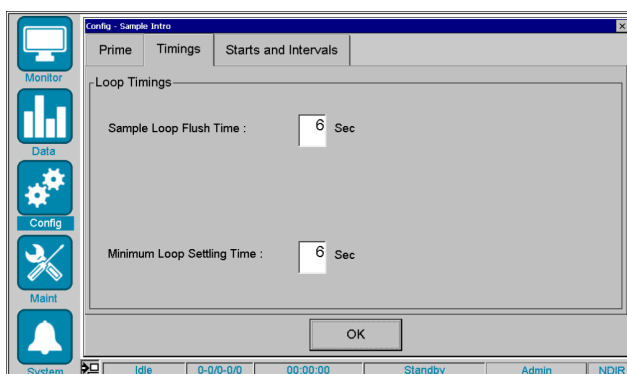

Figure 4.21 Config - Sample Intro - Timings Tab

The **Sample Loop Flush Time** is used to specify the time (in seconds) that the external (optional) valve should remain open prior to sampling from the fill-n-spill loop for the next sample. This time should be set based on the amount of time it takes for “fresh” sample to travel from the nearby “fast loop” at the sample tap to the sample inlet loop and perform a sufficient flush and replacement of the “old” sample remaining in the sample inlet loop. Once this time has been reached, the 9220 will automatically close the external valve for that loop. Typical times range from 15-60 seconds. The maximum flush time is 600 seconds.

NOTE: Excessive “flush” times may adversely affect the sample-to-sample cycle time of the analyzer, if the analyzer must wait for the sample to become available.

The **Minimum Loop Settling** timer begins when the flush time ends. Once the valve has been closed at the end of the flush time, the system will wait for the Minimum Loop Settling time (in seconds) prior to starting to Sample Prime or Replicate Prime the sample into the 9220 system. This settling time should only be needed if the sample contains particulates, and the analysis of those particulates as part of the TOC measurement is undesirable. Allow sufficient time for the particulates to settle, as needed. Typical times range from 0-15 seconds. The maximum settling time is 60 seconds.

NOTE: Excessive “settling” times may adversely affect the sample-to-sample cycle time of the analyzer, if the analyzer must wait for the sample to become available.

Starts and Intervals Tab

The **Starts and Intervals** tab is used to specify settings related to restarting, remote starting, and delayed-sample timing (Figure 4.22).

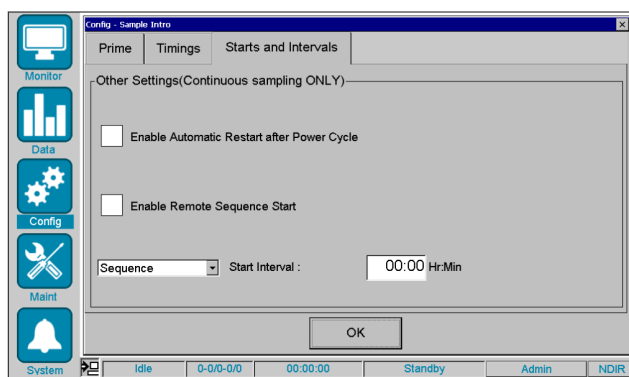

Figure 4.22 Config - Sample Intro - Starts and Intervals Tab

The **Enable Automatic Restart after Power Cycle** checkbox is used to enable a feature that instructs the 9220 unit to automatically resume the sequence in the event of an unexpected power cycle. If this checkbox is not checked, the 9220 will return to ready/idle after a power cycle and wait for operator input to restart the sequence. When attempting to restart the sequence, the 9220 system will automatically confirm that no error conditions exist prior to restarting the sequence.

NOTE: Because it is not possible to “complete” the analysis of an interrupted sample due to physical chemistry reasons, the system will restart the sequence at the beginning, starting with port 1, as if the start button has just been pressed after defining the sequence.

The **Enable Remote Sequence Start** checkbox is used to enable a feature that allows hardware handshaking between the 9220 system and another controlling device, so that the 9220 can be remotely started (per sample or sequence, based on the user selection). The start is triggered when the 9220 receives a potential-free contact closure “trigger” using the external inputs connector on the external connection board on the side of the 9220. If this checkbox is not checked, the system will process all samples in the sequence continuously, without waiting for the external start signal.

NOTE: Regardless of the type of start selected (sample or sequence), the operator **MUST** always initiate the sequence on the LCD touchscreen first by pressing the start button. The system will begin sequence preprocessing and then pause at the first sample to await the external trigger to start.

NOTE: Also, be certain that the contact-closure trigger is at least five seconds in duration, once the 9220 is in the “wait” condition, to ensure that the trigger is not missed.

The **Sample/Sequence (run selection)** allows the operator to determine if the remote start is triggered on a per-sample basis, or just once at the start of the sequence.

If **Sample** is selected, then the 9220 will stop at the start of each sample (after processing all replicates of the previous sample) and wait for the remote start to be triggered to begin processing the next sample.

If **Sequence** is selected, then the 9220 will only stop prior to the first sample of the sequence. Once the remote start is triggered, the 9220 will run the sequence continuously until a remote stop is issued, or the operator press the abort button on the monitor screen.

The **Start Interval (Hr:Min)** allows the operator to specify how long the 9220 should delay between starting.

- If **Sample** is selected **and Remote Start is disabled**, then the 9220 will wait automatically run each sample at the specified interval, if possible. For example, if the **Start Interval** = 01:00 (i.e., 1 hour), then the 9220 will automatically start each sample at the 1-hour interval. This is useful if the sample stream concentrations do not vary quickly, and thus 1-hour sample cycles can save reagents and reduce waste.

NOTE: *However, if the Start Interval time is set too short for all sample replicates to complete in time, then the next interval start will be missed, and the system will try to start again one interval later. For example, if the sample starts at 1:00 pm and the interval is 15 minutes, the next sample should start every 15 minutes (1:15 pm, 1:30 pm, etc.). But, if the sample takes 20 minutes to complete all of the replicates, then the 1:15 pm interval would be missed, and the interval timer would try again at 1:30 pm.*

- If **Sequence** is selected **and Remote Start is disabled**, the 9220 will restart the entire sequence at the specified interval, if possible. For example, if **Start Interval** = 01:00 (i.e., 1 hour), then the 9220 will automatically restart the entire sequence at the 1-hour interval. This is useful when the operator wants to cycle through all the sample streams at a routine schedule.

NOTE: *However, if the Start Interval time is set too short for the entire sequence to complete in time, then the next interval start will be missed, and the system will try to start again one interval later. For example, if the sequence starts at 1:00 pm and the interval is 1 hour, the sequence should restart every subsequent hour (2:00 pm, 3:00 pm, etc.). But, if the sequence takes 1 hour and 15 minutes to complete, then the 2:00 pm interval would be missed, and the interval timer would try again at the 3:00 pm hour.*

System Configuration Screen

The System Configuration screen consists of two tabs that define some basic hardware and software settings for the 9220 device. These include the following:

- System settings - for defining some basic operational parameters.
- Security settings - for defining the system security parameters.

System Settings Tab

Under **System Settings**, the operator is able to modify certain configuration settings related to the general operation of the TOC system, as well as settings for the TC Reactor.

Click the System Settings tab to access this screen (Figure 4.23).

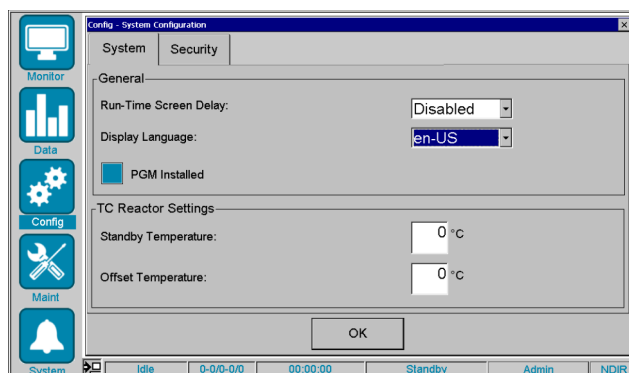

Figure 4.23 System Configuration Screen - System Settings

The **Run-Time Screen Delay** is used to set the amount of “user inactivity” time the system will wait before it automatically returns to the Run Mode screen. The delay time can be specified by clicking the drop-down and selecting the desired delay.

NOTE: This selection is not recommended when security features are intended to be in place.

The **Display Language** selection is used to specify the desired language used for all screens in the 9220 user interface. Select the desired language and click OK. A reboot of the system will be required for the selected language to be used.

The **PGM (Process Gas Module) Installed** selection specifies if the PGM is to be used as the gas supply for the 9220. The PGM is included with every 9220 device and is enabled by default. This checkbox instructs the 9220 to maintain the PGM accumulator pressure within its proper range of 16psi (+/- 2.0) psi. If the PGM pressure goes outside of this range, then an error will be issued and the 9220 will abort the current sequence and return to the Standby state.

NOTE: It is possible to turn this PGM feature off and switch to compressed gas (CO_2 -free Air, N_2 , or O_2) to perform system operations, if desired. In this case, the compressed gas must be regulated externally to stay in the same range of 16psi (+/- 2.0) psi. Otherwise, a pressure error will occur.

TC Reactor Settings can also be specified to tune the reactor heater for optimum sample analysis. These settings include the reactor Standby Temperature and Offset Temperature.

The **Standby Temperature** is used to specify the temperature at which the software will maintain the TC reactor when in the Standby state and during sample analysis. The temperature range is 0 to 120 °C.

The **Offset Temperature** is used to adjust the displayed temperature to match the actual sample temperature inside the TC reactor. This is factory set for normal operations at approximately 1000ft altitude. However, this offset adjustment may be particularly helpful for certain sample types or high-altitude installations of the 9220 system. The temperature offset range is +/- 15 °C.

Security Settings Tab

The **Security Settings** tab is used to enable and configure the 9220 security features. The 9220 system offers a basic 2-level security system, where two separate user accounts can be created, each with individual pre-defined security access permissions. By default, System Security is disabled, so that the installer/operator can configure and manage the system as needed. See Figure 4.24.

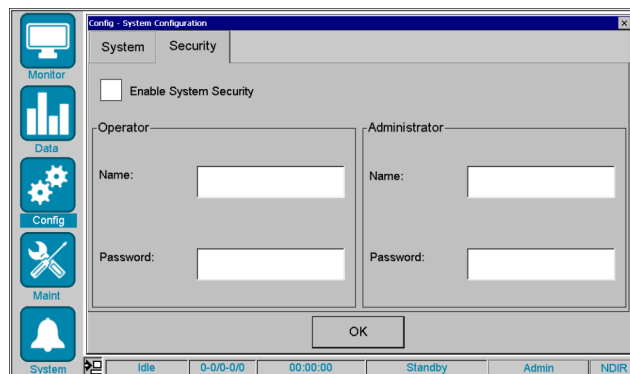

Figure 4.24 System Configuration Screen - Security Settings

If **System Security** is enabled, then both the Operator and Administrator accounts must be defined.

To switch between user accounts, click the User button on the bottom Status Bar and a prompt screen will appear to enter the User ID and Password.

Modbus Settings Screen

The **Modbus Settings** screen defines the settings required to configure the Modbus communications feature of the 9220 system. This feature allows the 9220 to be connected to a SCADA-type system for command, control, and monitoring purposes using the site's existing SCADA infrastructure.

NOTE: This feature requires that the optional 9220 Modbus/SCADA module be purchased and installed with the 9220 system. This module can be wired for RS-422 or RS-485 hardware configurations. See the specification sheet for this module for more details.

Click the **Modbus Settings** icon to view this screen (Figure 4.25).

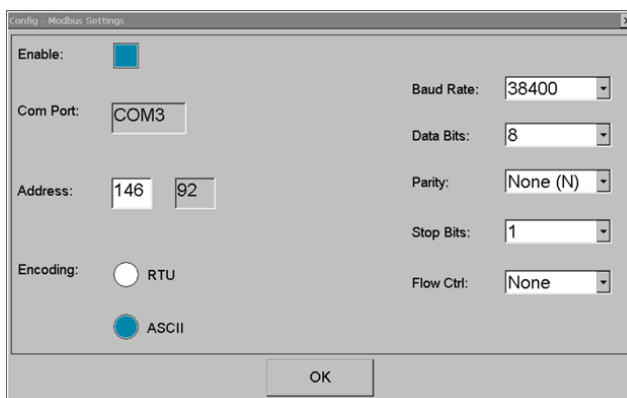

Figure 4.25 Config - Modbus Settings

The various connection parameters are listed in the table below. These parameters need to be configured to match the SCADA system to which the 9220 is being connected. Consult the installation site's required protocol settings to properly configure the 9220 system (Table 4.7).

NOTE: For more details on the Modbus/SCADA programming, see the 9220 Modbus/SCADA Programmer's Guide provided with the 9220 Modbus/SCADA Module.

Item	Description
Enable	Enables or disables the Modbus/SCADA feature Default = Disabled
Com Port	Internal Com port of the 9220 Default = COM3 (not changeable)
Address	Specifies the Modbus Device ID/Address for the 9220 unit. This address must be unique on the site's SCADA network. Input as a decimal. Also shown as HEX.
Encoding	Encoding selection options: RTU and ASCII Default = ASCII
Baud Rate	Baud rate selections available: 38400, 57600, and 115200 Default = 38400
Data Bits	Data bits selections available: 5, 6, 7, and 8 Default = 8
Parity	Parity selections available: None, Odd, and Even Default = None
Stop Bits	Data bits selections available: 0, 1, and 2 Default = 1
Flow Control	Flow control options: None, Hardware, and Software Default = None

Table 4.7 Config - Modbus Settings - Parameters

Analog Output Screen

The **Analog Output** screen defines settings for controlling the output level of the four (4) built-in 4-20mA output channels. These current-loop outputs can be used as inputs to the site's analog data acquisition network for monitoring the sample concentration readings and port values using existing infrastructure.

Click the **Analog Output** icon to view this screen (Figure 4.26).

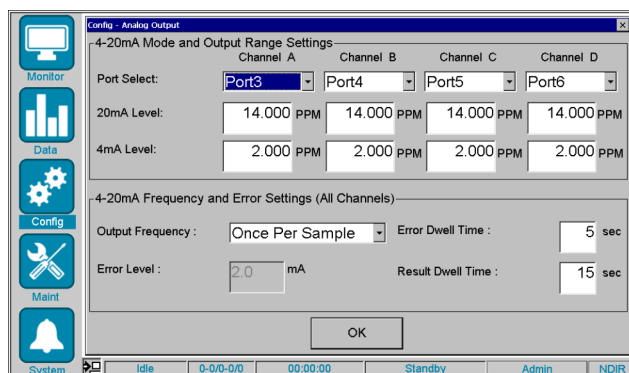

Figure 4.26 Config - Analog Output Screen

The **4-20mA Mode and Output Range Settings** section allows the operator to specify the port number and define the range of TOC concentration output for each of the 4 output channels (Channels A thru D).

The **Port Select** field allows the operator to select which sample port data to send to each output channel (A thru D). Typically, these are set to ports 3 thru 6, since those are the pre-defined sample ports for the 6-port sampler. (Ports 1 and 2 are used for calibration standards).

The **20mA Level** setting specifies the TOC concentration value (in PPM) to be equated to 20.0mA output on each Channel (A thru D). Each channel can specify a different TOC concentration level since each port may be monitoring a different part of the water analysis (or treatment) process at the site. Max = 30,000ppm.

The **4mA Level Setting** specifies the TOC concentration value (in PPM) to be equated to 4.0mA output on each Channel (A thru D). Each channel can specify a different TOC concentration level since each port may be monitoring a different part of the water analysis (or treatment) process at the site. Max = 1000ppm and must be less than the 20mA level concentration.

NOTE: The nominal range of analog output is 16.0mA (i.e., from 4.0 - 20.0mA), which can be correlated to a specific range of desired concentration output. For example, if the 4mA Level value = 0ppm and the 20mA value = 20ppm, then a 10.0ppm sample measurement will result in a 12.0mA output.

As a special analog output configuration, the Port Select setting for Channel B provides an additional option to output the port # of the sample analyzed (as a mA value), when Channel A is set to **All Ports**. Thus, the TOC Concentration value on Channel A can be correlated to a specific sample port based on the sample port number output by the Channel B output level. See Figure 4.27.

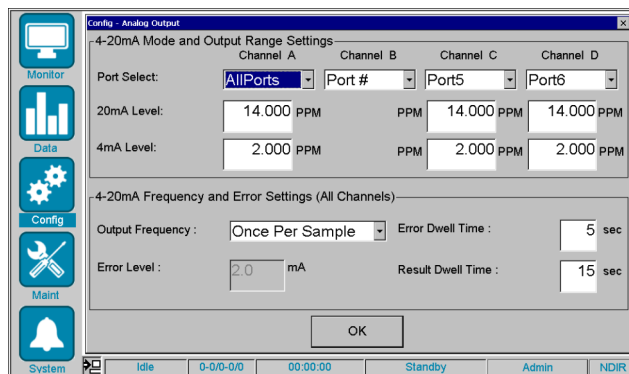

Figure 4.27 Config - Analog Output Screen - All Ports Option

In this case, the TOC Concentration value (in mA) is output on Channel A, while the port # output value (in mA) is output on Channel B, which is defined as follows:

Channel B value:

- 6mA = Port 1
- 8mA = Port 2
- 10mA = Port 3
- 12mA = Port 4
- 14mA = Port 5
- 16mA = Port 6

The 4-20mA Frequency and Error Settings section allows the operator to specify which 4-20mA output channel should be triggered when an out-of-range concentration error condition occurs. When a concentration range error occurs, the system will automatically change the 4-20mA output level from its current value to the error level (mA) value and back again, making a square-wave style output.

The Output Frequency field specifies the frequency of the output data being updated to the 4-20mA output channel. The frequency selections are **Once per Sample**, **Once per Replicate**, or **Never**.

Selecting the **Never** option disables the Analog Output feature. Selecting **Once per Replicate** means that the analyzer will automatically send a new output level value upon computing the concentration for every replicate that is analyzed. Selecting **Once per Sample** means that the analyzer will automatically send a new output level value only after completing all replicates of the current sample and will use the Average Concentration as the output value.

NOTE: The output level on each analog channel will remain at the most recent level (i.e., concentration value) until a new sample (or replicate) is processed when the output value will update.

The Error Level (mA) value is predefined as 2mA.

The Error Dwell Time and Result Dwell Time define the duration of each length of those square-wave segments when the system is indicating an error condition. When an error condition exists, it automatically triggers the Error Level output (2mA) for the duration of the Error Dwell Time, and then switches back to the nominal output level (based on the sample concentration) for the duration of the Result Dwell Time, then continues until the error is reset or a new sample concentration value is analyzed. The maximum value for each of these settings is 60 seconds, and the 20mA value must always be greater than the 4mA value. The Error Dwell Time can be set to 0 seconds, which basically eliminates the square-wave output feature.

NOTE: Output Frequency, Error Dwell Time, and Result Dwell time are specified the same for both the Analog 0 and Analog 1 output channels.

Alarm Settings Screen

The Alarms Settings screen consists of two tabs that define the triggering of System and Sample alarms in the 9220 device. Click the Alarm Settings icon to view this screen.

Relay 1 - System Alarms Tab

The Relay 1 - System Alarms Tab is used by the operator to configure certain predefined system events as either errors or warnings. By default, the Relay 1 - System Alarms tab always appears first when accessing the Config → Alarm Settings screen (Figure 4.28).

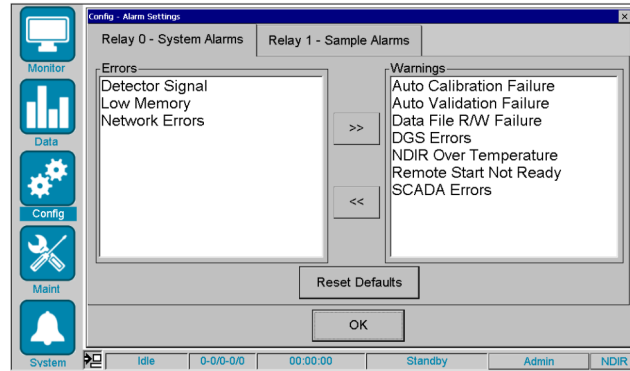

Figure 4.28 Config - Alarm Settings - Relay 0 - System Alarms Screen

The Errors List shows which items are specified to be system errors, and thus will trigger the Relay 1 - System Error alarm relay.

The Warning List shows which items are deemed to be system warnings, and thus will not trigger the Relay 1 - System Error alarm relay, but will, however, be noted in the Run Log and Alarms Log as warnings that occurred.

The "<<" and ">>" buttons are used to move selected items from one list to another.

The Reset Defaults button is used to reset both lists to the original factory defaults for each.

Relay 1 - Sample Alarms Tab

The Relay 2 - Sample Alarms Tab is used to define settings for triggering TOC concentration-based sample alarms for each of the four pre-defined Sample Ports (ports 3 through 6; Figure 4.29).

These alarms will be used in three forms:

- As an LED indicator in the Alarms section on the main Monitor Screen
- As a relay trigger on the Relay 2 - Sample Alarms relay
- As high and low warning and alarm "limit lines" on the Data → Trend and the individual Port → Trend charts

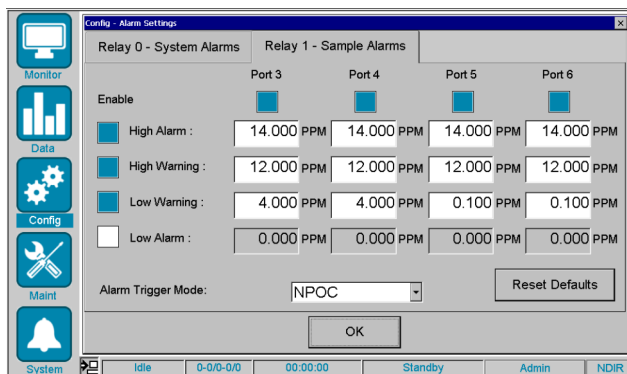

Figure 4.29 Config - Alarm Settings - Relay 1 - Sample Alarms Screen

The **Alarm Trigger Mode** determines which analysis mode results will be used to determine if a concentration alarm should be triggered. The mode(s) not selected will be ignored and will not trigger any alarms. Trigger Mode is always NPOC, which means the TOC/NPOC value will be used for evaluating the alarm condition.

The **Port Enable Checkbox** for each port indicates if that port should be monitored for out-of-range concentration alarms/warnings. Enable each port that needs to be monitored.

The **Alarm Enable Checkbox** for each of the alarms and warnings determines which alarms or warnings are to be utilized across all the enabled ports. If a warning or alarm is disabled, it will not trigger an alarm, even if a sample concentration exceeds the concentration value specified.

The **High Alarm Field** specifies the sample concentration level that, above which, will trigger a Sample Alarm on Relay 2 for that given sample port, will also light the corresponding LED on the monitor screen, and will flash the concentration value on the run screen in red.

The **High Warning Field** specifies the sample concentration level that, above which, will indicate a Sample Warning (but NOT trigger Relay 2) for that given sample port, will also light the corresponding LED on the monitor screen, and will flash the concentration value on the run screen in yellow.

The **Low Warning Field** specifies the sample concentration level that, below which, will indicate a Sample Warning (but NOT trigger Relay 2) for that given sample port, will also light the corresponding LED on the monitor screen, and will flash the concentration value on the run screen in yellow.

The **Low Alarm Field** specifies the sample concentration level that, below which, will trigger a Sample Alarm on Relay 2 for that given sample port, will also light the corresponding LED on the monitor screen, and will flash the concentration value on the run screen in red.

The relationship between the concentration values of these four fields must be as follows:

High Alarm Conc → High Warning Conc → Low Warning Conc → Low Alarm Conc

NOTE: The *Low Warning* and *Low Alarm* fields can not only be used for process control if an unexpectedly low TOC value is calculated, but can also indicate that some system maintenance may be required. This may include low reagent levels, or possible heating or oxidation issues.

Alarm notices will also be posted in the alarms log, which can be accessed by selecting the **Alarms** icon at the top of the main window.

When an alarm is triggered, it can be reset by clicking **Reset Alarms** on the alarms screen. Alarms will be re-evaluated after each sample replicate is analyzed.

Set Date Time Screen

The Set Date/Time Screen allows the administrator to set the date and time on the 9220 system. Click the Set Date/Time icon to view this screen (Figure 4.30).

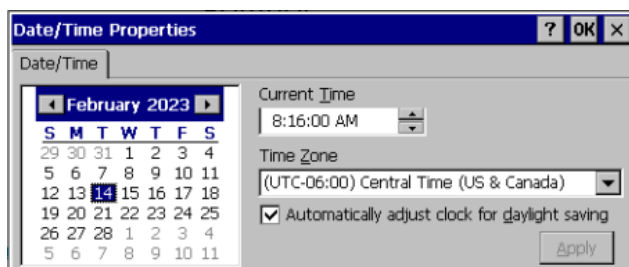

Figure 4.30 Date/Time Properties Screen

Press the left arrow on the calendar to see the previous month. Press the right arrow to advance the month. Press on the desired date on the calendar to select. The operator should set the system date and time to synchronize time values for the 9220 instrument and the PC. This is essential for the system to accurately log events and sample analysis results. Press the **Current Time** field to make changes of hours, minutes, seconds and AM/PM. Select the appropriate **Time Zone** and check the **Daylight Savings** time box if appropriate. Press **Apply** to save the settings.

NOTE: Due to the limitations of the Windows CE Operating System, this window may be a bit difficult to use. Recommend using a stylus for entries in Date and Time.

4.6 Maintenance Screen

Pressing **Maint** opens the maintenance screen, which provides operator control over analyzer components and accessories for diagnostic support (Figure 4.31).

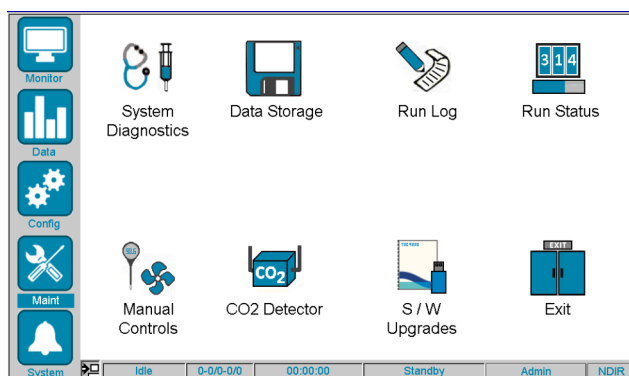

Figure 4.31 Maintenance Screen

System Diagnostics Screen

The System Diagnostics Screen provides the operator access to four diagnostics screens. The screens provide the ability to view instrument software and firmware versions, review file system status, create diagnostic logs, and perform system archive and restore operations.

System Info Tab

The System Info tab provides the operator with a single screen to view the software, firmware, and circuit board revisions for all internal and external components of the 9220 system. See Figure 4.32.

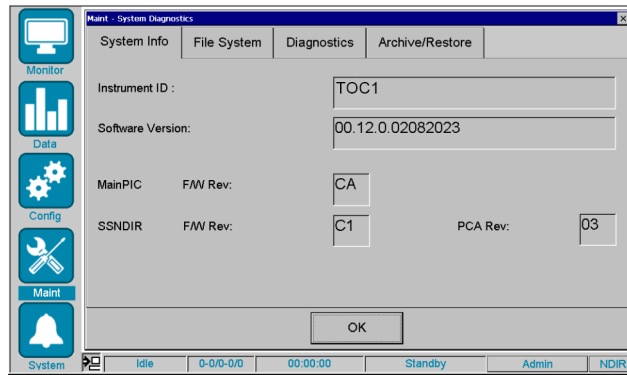

Figure 4.32 Maint - System Diagnostics

The Instrument ID (or serial number) for the 9220 system is displayed. This information can be very helpful in determining the ability to perform compatibility checks for upgrades and/or replacements to the hardware or software in the future.

The Software Version field shows the version number and build date of the 9220 user-interface software.

The Firmware Revision and PCA Rev fields for the Main Pic Controller and SSNDIR Detector reflect the information read directly from those respective boards.

NOTE: This information is read-only and cannot be modified by the operator. If any of this information is blank, or contains "garbage" information, it could indicate the inability of the 9220 software to properly communicate with a given circuit board.

File System Tab

The File System tab provides the ability to review the Total, Used, and Free permanent storage capacity on the 9220 device. See Figure 4.33.

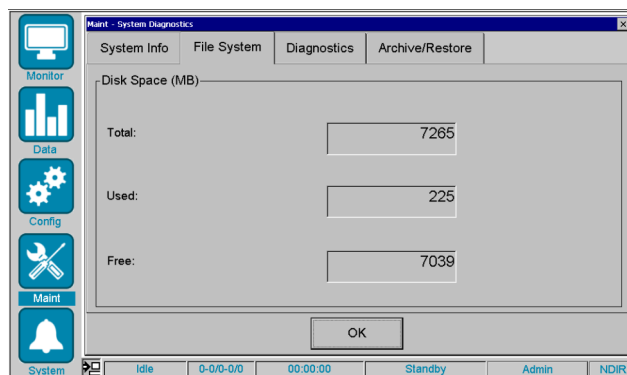

Figure 4.33 Maint - System Diagnostics - File System

This information can be helpful in determining when the onboard data storage needs to be downloaded and cleared to make room for future data. The free disk space should never fall below 500 KB as unpredictable results may occur.

Diagnostics Tab



The Diagnostics tab provides the ability to create, copy, and clear diagnostic files. See Figure 4.34.

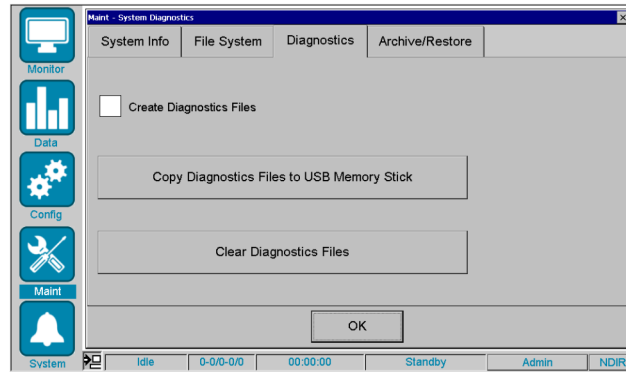

Figure 4.34 Maint - System Diagnostics - Diagnostics

These diagnostic files can often be helpful if an unexplained error occurs during the operation of the 9220 system. These diagnostic files track numerous parameters and keep a log of system communications between internal and external devices.

To start a diagnostics session, enable the **Create Diagnostics Files** checkbox. This will immediately begin to log all of the diagnostics information that the 9220 device can track. This information is stored locally on the permanent storage file system and will remain there until the Clear Diagnostics Files feature is used.

However, if a copy of the Diagnostics Files needs to be reviewed, it can be downloaded using the **Copy Diagnostics Files to USB Memory Stick** option and viewed on a separate PC. To create a copy, insert the USB memory stick into the 9220 USB port, then click the **Copy Diagnostics Files to USB Memory Stick** button to begin the process. This may take up to a few minutes, depending on the size of the diagnostics files.

NOTE: *When working with USB memory sticks, always be sure to check the small LED light (if one exists) on the memory stick for activity before removing it. Some USB memory sticks will show a flashing LED light to indicate activity (i.e., reading or writing data), while others will show a solid LED light for activity. Some will show no LED light when inserted, while others will show a solid LED light when inserted. Be sure to test your USB memory stick to know its behavior. Do not remove a USB memory stick while activity is occurring, as this may result in data corruption on the device.*

Once the diagnostics files are no longer needed, disable the Create Diagnostics Files checkbox. Then, press the Clear Diagnostics Files to erase the files to free up the space on the permanent storage drive.

NOTE: *Do not leave this feature on for long periods of time, as the internal drive may run out of available storage for data.*

Archive/Restore Tab

The Archive/Restore tab provides the operator the ability to create and restore system

“archive” files. These files include all of the stored information related to the 9220 system configuration. See Figure 4.35.

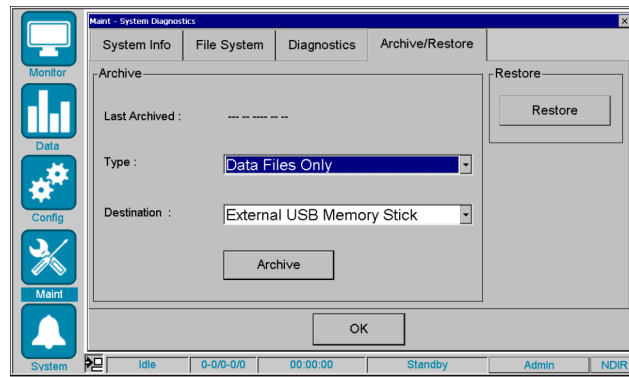

Figure 4.35 Maint - System Diagnostics - Archive/Restore

The **Archive** feature allows the operator to create a backup image of some or all system files and stores that image on a USB memory stick, which must be inserted prior to initiating the archive operation. The system can make an indefinite number of archives, so long as they can fit on the memory stick.

The **Last Archived** field shows when the last manual archive operation was performed.

The **Type** field offers two options when performing an archive:

- **Complete System Backup** - This option makes a copy of all program and data files which can be restored if any files are lost or corrupted.
- **Data Files Only** - This option makes a copy of only data files (not program files) which can be restored if any undesirable changes to systems settings were made.

NOTE: A complete system backup should be performed immediately after the 9220 system is installed and all the configuration and method settings are adjusted to best suit the application needs. After that, a "Data Files Only" archive backup should be performed if other changes are made to the system parameters.

The **Destination** field offers two possible locations for saving archive data:

- **External USB Memory Stick** - This option saves the archive data to the external USB stick located on the front panel next to the display screen.
- **On-board USB Memory Stick** - This option saves the archive data to the internal disk.

The **Restore** features offers the operator the ability to review previous archives from the USB memory stick, select which archive is to be used, and perform the restore activity. The Restore option will replace existing files on the 9220 device with the versions found in the archive selected.

NOTE: This feature is best used to recover previous system settings that have been lost or overwritten, or in the event that the 9220 computer board needs to be replaced.

NOTE: The Archive and Restore features can only be used when the 9220 system is in the Standby state.

Data Storage Screen

The Data Storage screen allows the operator to manage the sample and calibration data that has been analyzed and stored on the 9220 device. It displays the number of samples and calibrations currently stored on the device and provides an archive feature to allow those data files to be downloaded to a USB memory stick. Click the Data Storage icon to view this screen (Figure 4.36).

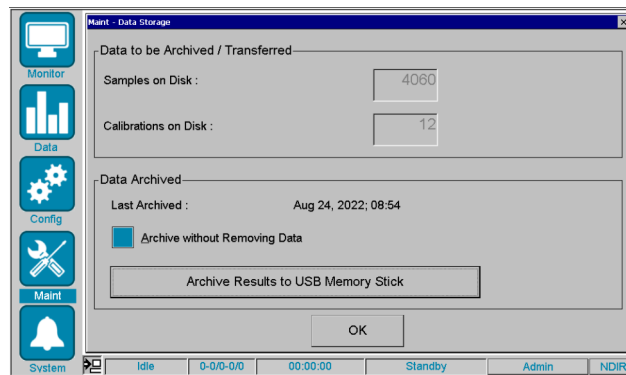

Figure 4.36 Data Storage Screen

The **Samples on Disk** field shows the number of sample results that have been stored on the device since the last time the device memory was cleared. The system will store in excess of 50,000 sample results.

NOTE: The operator must routinely archive and remove the data to avoid running out of disk capacity, which could result in unpredictable system behavior.

The **Calibrations on Disk** field shows the number of calibration results that have been stored on the device since the last time the device memory was cleared. The system will store up to 1,000 calibration results.

The **Last Archived** field shows the date and time when the last Archive Results to USB memory stick operation was performed.

The **Archive without Removing Data** option allows the operator to perform an archive operation without removing the results from the device memory. This is useful for maintaining the recent data history when reviewing results on the device.

The **Archive Results to USB Memory Stick** feature allows the operator to back up the data stored on the device to USB Memory stick, which is inserted on the front panel next to the display. This data is in ASCII human-readable format.

Archiving Results to USB Memory Stick

Preparing the USB Memory Stick

To archive data to a USB memory stick, the memory stick must first be configured by the operator to have a specific directory already created for archiving purposes. That directory is: `\TOC9220\Archive`.

See the below for an example USB memory stick directory listing in Windows Explorer (Figure 4.37).

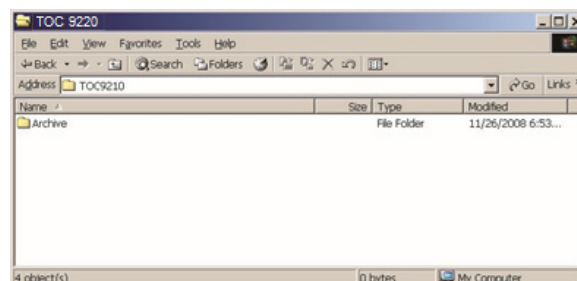

Figure 4.37 Directory Structure Required for USB Memory Stick

If the proper archive directory structure does not exist on the USB memory stick, or there is no USB memory stick installed in the 9220 device, the following error message may appear (Figure 4.38).



Figure 4.38 USB Memory Stick Archiving Error

Archiving to the USB Memory Stick

- Insert the USB memory stick into the USB port on the front panel of the 9220 system.
- Click **Archive Results to USB Memory Stick** to initiate the archiving process. This process will automatically search for an attached USB memory stick with the “\TOC9220\Archive” directory, create a unique subdirectory for this archive using the current date and time (e.g., “_02_05_2009_08_13_35”), and copying the current sample results and calibration data into two lower-level subdirectories named Results and Calib, respectively.
- Data archiving will typically take 10-30 seconds to complete. While the data is being archived a message screen will appear indicating that the archive is in process (Figure 4.39).

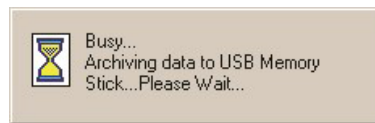

Figure 4.39 Archive to USB Memory Stick in Process

- Once complete, the above message disappears, and the **Maint → Data Storage** screen will be updated to show the new “Last Archived” date.
- Remove the USB memory stick and replace the cover on the USB port.
- Once the archive is complete, the system will have created the new archive directory and subdirectory and copied the sample results file and calibration file.

Run Log Screen

The **Maintenance Run Log** screen shows a list of up to 300 system messages, listed in order from the oldest at the top to the most recent at the bottom. Click the **Maint → Run Log** icon to view this screen (Figure 4.40).

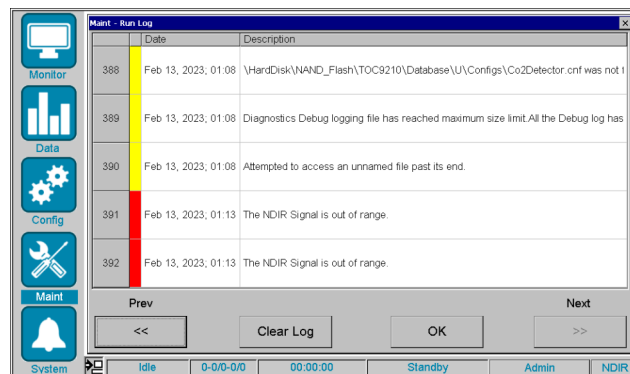

Figure 4.40 Run Log Screen

Color-coded icons indicate each message's severity. The blue icon represents an informational message, such as a sequence that was loaded or started. The yellow icon means a warning message, such as a configuration warning. The red icon indicates an error message, such as a hardware component failing to perform its task when first asked.

NOTE: Just because a warning or error message appears does not mean the system did not eventually complete the task.

Double-click on any message to get a popup screen with more details about that item (Figure 4.41).

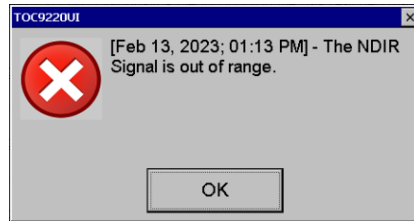

Figure 4.41 Run Log Screen - Message Details

Press Clear Log near the bottom of this screen to delete all log entries.

Run Status Screen

The Run Status Screen shows the progress of the sample and replicate that is currently being analyzed, as well as the progress of the next sample replicate that is being preprocessed. Typically, this level of detail is not needed when running in a normal analysis mode. However, it can prove useful when performing some troubleshooting operations, where it may be necessary to understand where the system is in the process when a particular analytical or mechanical event may occur.

Click the Maint → Run Status icon to view this screen (Figure 4.42).

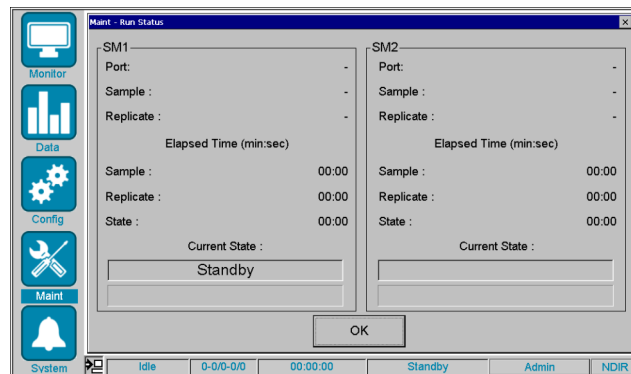

Figure 4.42 Maint - Run Status Screen

Internally, the 9220 system uses two parallel State Machines to perform all the steps required for 9220 sample-processing operations. These two state machines interact with each other to optimize system performance and reduce system cycle time. As a new sample replicate is to be analyzed, the next available state machine assumes that responsibility. The state machines alternate for primary control of the system operations and use of the hardware. To better follow the activities of each state machine, a separate set of information is provided for each.

The information available includes the **Port**, **Sample**, and **Replicate** numbers, which can be best used for tracking the sequence's progress and to know which sample port is being analyzed at present and which port is next to be analyzed.

In addition, **Elapsed Time** for the current **Sample**, **Replicate**, and **State** are provided. These times can be useful to understand how much total time is being used to analyze a sample, in the event that this analyzer is being used as a part of a timed process.

Finally, the Current State name and a progress bar are shown. There are several states that will appear in this field, depending on the analysis mode being performed, including:

- Waiting to Start Rep
- Prime Sample
- Load Sample and Reagents
- TIC Removal
- Transfer Sample and Reagents
- Inject Persulfate
- React TOC
- Detect TOC
- End TOC
- Calculate Replicate/Sample
- End Replicate/Sample

Manual Controls Screen

The **Manual Controls Screen** provides access to several screens that allow for almost complete manual control of the 9220 device. These features include the ability to control each valve individually, and the syringe pump, as well as the ability to run some predefined “macro” commands. Also, it allows the operator to view some live feedback on the status of these controls, along with the NDIR detector output in digital and strip chart form.

Click the **Maint** → **Manual Controls** icon to view the **Detector** screen by default.

For more details on the 9220 system, refer to [Section 7.2: 9220 Plumbing Diagram](#).

NOTE: Although the Manual Controls Screen is available at any time, the buttons and macros that directly affect system operation are not available for use unless the system is in the Standby State.

Detector Tab

The **Detector** tab provides access to directly read and graphically view the current signal output from the NDIR detector (Figure 4.43).

Press **Maint** → **Manual Controls** → **Detector** tab to view the Detector screen.

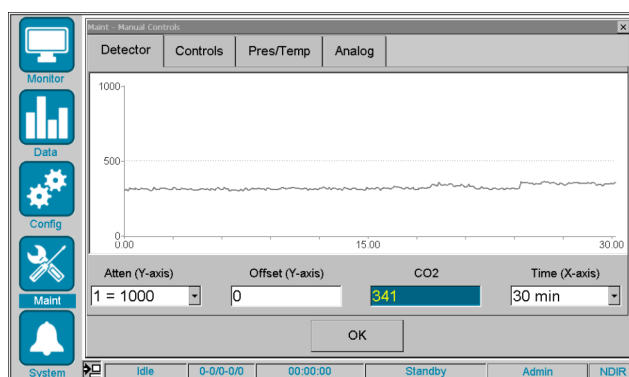

Figure 4.43 Manual Controls - Detector Screen

The **Graphical Strip Chart** shows the most recent data received from the NDIR detector and displays up to 90 minutes of that data in the chart. The chart is generated by the most recent readings entering from the right side of the screen, then moving across the screen from right-to-left.

The **Chart Line** is displayed in two different colors: gray and green.

- **Gray** - represents when the detector is "idle" (i.e., not in a "detect" state)
- **Green** - represents when TOC detects data is being captured

The **Attenuation and Offset Values** are used to control the scale of the Y-axis, which represents the signal output in raw (i.e., nonlinearized) signal output. The signal output can range from 0-65535.

The **Attenuation Value** specifies the range of the Y-axis. These values are predefined increments (Figure 4.44).

1 = 1000
2 = 2000
3 = 5000
4 = 10000
5 = 20000
6 = 40000
7 = 80000

Figure 4.44 Range of Y-axis

The **Offset Value** specifies the minimum value for the Y-axis. The default is 0 but can be changed so as to move up closer to the baseline of the peak trace.

The **CO₂ Signal Value** displays the most recent data point that has been read from the detector. It is updated approximately once every 2-3 seconds. This value also represents the newest data being displayed at the right edge of the graphical chart.

The **Time (X-Axis) Value** specifies the time scale of data to be displayed. The system will only maintain a memory of the last 90 minutes of data, so data beyond that point cannot be displayed on the chart. The range of time value settings is shown in Figure 4.45.

Whenever any of the chart settings on this screen are changed, the chart will automatically reflect these changes during its next refresh, which occurs every 2-3 seconds.

10 min
20 min
30 min
60 min
90 min

Figure 4.45 Range of Time Value Settings

Controls Tab

The **Controls** tab provides access to the 6-port valve, the manual valves, and some system macros. When any of these items are on or "active", then will appear in blue.

Otherwise, when valves are off or "inactive", they will appear in gray (Figure 4.46).

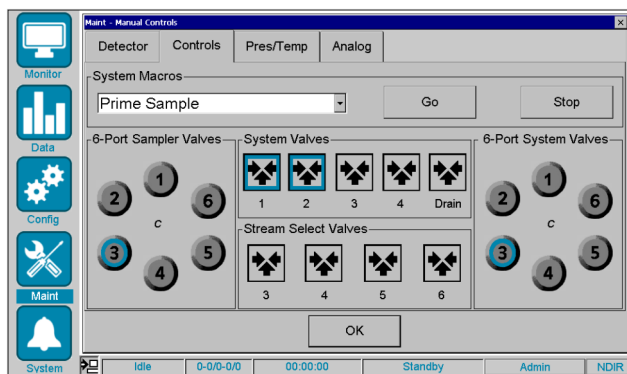

Figure 4.46 Manual Controls - Loop Screen

System Macros

In addition, the Controls tab provides access to some predefined System Macros, as shown below (Figure 4.47).

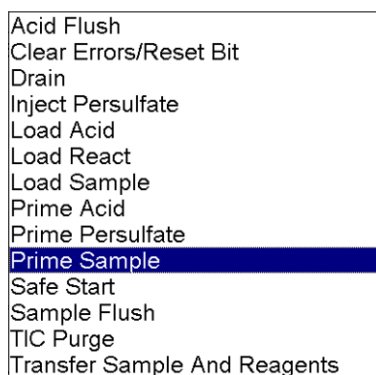

Figure 4.47 System Macros

To start a macro, select the desired system macro and select the **Go** button.

To stop a macro, select the **Stop** button.

NOTE: *Not all macros can be stopped immediately and may continue to the next logical stopping point in the macro before the macro terminates.*

The **Acid Flush Macro** is provided as a maintenance cleanup macro only and is not currently used during sample processing. It rinses the sample pathway with acid to reduce sample carryover.

The **Clear Errors/Reset Bit Macro** allows the operator to manually clear any error bits that may exist. This is typically only an internal software task, but it is also available for manual usage.

The **Drain Macro** will perform the same macro to drain all the sample and acid from the system at the end of each sample replicate. This would typically be performed after the TIC detect steps when processing a sample.

The **Load Acid Macro** will perform the same macro to load the volume of acid specified in the **Config → Method Settings** into the system valve and syringe as will be performed when loading every sample replicate during a sample analysis. This would typically be performed before the TIC removal macro when processing a sample.

The **Load Sample Macro** will perform the same macro to load the volume of sample specified in the **Config → Method Settings** into the system valve and syringe as will be performed when loading every sample replicate during a sample analysis. This would typically be performed before the Load Acid macro when processing a sample.

The **Prime Acid Macro** will perform the same macro to prime the acid from the reagent bottle into the system valve and syringe as will be performed at the beginning of a sequence, using the Acid Prime Volume specified in the **Config → Sample Intro** screen. This would typically be performed before the Prime Sample macro when starting a sequence.

The **Prime Persulfate Macro** will perform the same macro to inject the volume of persulfate into the TC reactor to prime the persulfate pump and inject lines. After priming, the drain macro should be used to drain the TC reactor.

The **Prime Sample Macro** will perform the same macro to prime the sample from the sample inlet into the system valve and syringe as will be performed at the beginning of each sample replicate, using the Sample Prime Volume specified in the **Config → Sample Intro** screen. This would typically be performed before the Load Sample macro when processing a sample.

The **Safe Start Macro** will perform the same macro that is used when the 9220 system is first powered up. This will drain the TC reactor and reset all valve to their default position after drain is complete.

The **Sample Flush Macro** will perform the same macro to flush the entire sample loop with sample from the sample inlet as performed at the beginning of each sample replicate if Flush with Sample before Analyzing is specified in the **Config → Sample Intro** screen. If enabled, this would typically be performed before the Load Sample macro when processing a sample.

The **TIC Purge Macro** will perform the same steps used after the sample and acid are both drawn into the syringe and the purge gas is turned on to remove the CO₂ from the sample in the syringe.

The **Transfer Sample and Reagents Macro** will perform the same macro to transfer the sample in the syringe, through the 6-port system valve and valve manifold, and into the TC reactor, as will be performed when transferring every sample replicate during a sample analysis. This would typically be performed before the TOC react macro when processing a sample.

Six-Port Sampler Valve

The Six-Port Sampler Valve buttons allow the operator to manually change the port position of the 6-port sampler valve. This position determines which sample port can be directly accessed by the system valve for aspirating sample. The blue highlight indicates the current position. Click another port position and the valve will rotate to that sample port position, and the blue highlight will switch to that port number button when the move is complete.

Stream Select Valve

The Stream Select Valve control buttons allow the operator to manually actuate (ON/OFF) any of the four (4) optional sample valves that are available for the fill-n-spill sample ports. A blue highlight will indicate that the valve is on.

System Valves

The System Valves control buttons allow the operator to manually actuate (ON/OFF) any of the four (4) valves on the main valve manifold. These are labeled as valves 1 through 4. The drain valve is mounted on a separate manifold. A blue highlight will indicate that the valve is on.

Six-Port System Valve

The Six-Port System Valve buttons allow the operator to manually change the port position of the 6-port system valve. This position determines whether the port of the system valve can be directly aspirated/dispensed via the syringe pump. The blue highlight indicates the current position. Click another port position and the system valve will rotate to that port position, and the blue highlight will switch to that port when the move is complete.

Pressure/Temperature Tab

The **Pres/Temp** tab provides access to the current readings for the 9220 system pressure and PGM pressure sensors and the various heated zones in the device.

Press the **Maint → Manual Controls → Pres/Temp** tab to view the Pres/Temp screen (Figure 4.48).

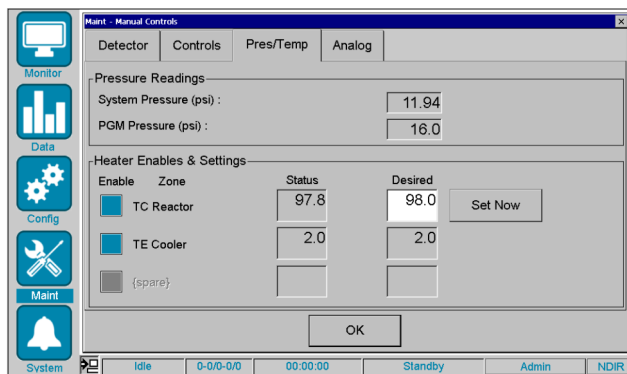

Figure 4.48 Maint - Manual Controls - Pres/Temp

Pressure Readings

The 9220 system has two built-in pressure sensors on the Main PIC Control board, which are used for monitoring the system (EPC) and PGM pressure levels.

The **System (EPC) Pressure Sensor** measures the pressure at the EPC valve on the main 5-valve manifold. Nominally, this pressure should be 13.0psi ± 1.0psi. Under certain conditions, the system pressure may briefly exceed these ranges, which will typically result in a pressure warning. However, a sustained system pressure outside of this range will result in a pressure error and will cause the 9220 system to abort the current sequence and return to standby state. This is a safety mechanism used to protect the 9220 system from possible flooding when attempting to move the sample and reagent liquids when insufficient gas pressure is available.

The **PGM Pressure Sensor** measures the pressure between the PGM pump and PGM accumulator. This pressure will typically range from 15-17 psi, but may have brief excursions outside of that range, as the accumulator is re-pressurized. A pressure error will be issued if the PGM pressure is more than 1.5psi out of range.

NOTE: The PGM pressure sensor is only error-checked when the PGM Option Installed checkbox is enabled on the Config → System Configuration → Misc. screen.

Heater Enables and Settings

The **Enable** checkboxes allow the operator to Enable or Disable the individual heated zones. If unchecked (i.e., disabled), the heated zones will be turned off and will eventually equilibrate at ambient temperature.

The **Current Temp** fields show the current temperature of the individual heated zones, adjusted for offsets.

The **Desired Temp** fields show the current desired setpoint temperature of the individual heated zones. To change the desired setpoint, enter a new value and click **Set Now**.

Analog Tab

The **Analog** tab allows the operator to test and adjust the 4-20mA output connections and test the two output relays (Figure 4.49).

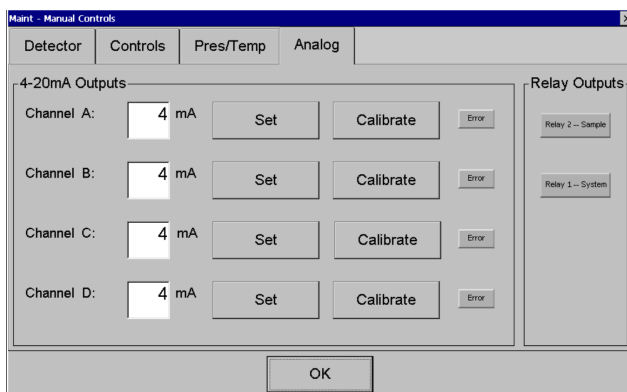

Figure 4.49 Maint - Manual Controls - Analog

This can be very useful when first connecting the 9220 system to an existing analog data acquisition system in loop-powered mode (via an internal jumper on the main PIC board. Press the Maint - Manual Controls - Analog tab to view the Analog screen.

4-20mA Outputs

The 9220 system has four (4) built-in 4-20mA output connectors (one for each of the analog channels (A thru D) on the **External Connection** board. These are used for outputting the most recent sample concentration value, or port number, as an analog current (mA) value.

The 4-20mA outputs can be configured on the **External Connection** board to be either “self powered” or “loop powered” depending on the needs of the loop to which the 9220 device is being connected. Refer to the **Power and Data Connections** section of **Section 4: User Interface** for more details on these connectors and jumper settings.

NOTE: *The actual overall range of the analog channels on the External Connection board is 0-25mA but is software-limited to 4-20mA for compatibility purposes.*

The **Set** button can be used to output a user-specified analog (mA) value on a given channel. Enter a desired test value (between 0.0 and 25.0mA) in the data entry field and click Set. The 9220 will immediately set that value to that analog channel, which can then be measured via the sites analog data acquisition system.

NOTE: *To verify the overall accuracy of the analog outputs, it is recommended that each channel be tested and verified at both the 4mA and 20mA levels. If a given analog output channel requires some adjustment for better accuracy, use the calibrate feature to correct the output. See the **Analog Output Calibration** screen.*

The **Error** button can be used to verify the error toggle features of the 9220 system. When in the error toggle mode, the error button will be highlighted in green.

During normal sample processing, if the calculated result value (in PPM) for a given sample is outside of the high or low alarm range for that analysis mode, as specified in the Config - Alarm Settings screen, then the error toggle feature will be activated for the 4-20mA output channel.

The **Error Toggle** feature will essentially create a “square wave” pattern on the analog output channel, by alternating between the “normal” output level (as defined by the PPM of the sample) and the “error” output level, which is pre-defined as 2.0mA. The frequency and duration of this square-wave output are defined on the **Config → Analog Output** screen.

Relay Outputs

The **Relay Outputs** section allows the operator to test both output relays using their facility’s control system before going to “live” condition.

The **Relay 1 - System** relay button allows the operator to test the triggering of the system error relay, which is relay 1. The system will automatically abort the sequence and return to the standby state if the relay 0 is triggered during normal operations. The button will be highlighted in green when the relay is activated for this test.

The **Relay 2 - Sample** relay button allows the operator to test the triggering of the sample error relay, which is Relay 2. This relay is used to indicate that a sample concentration or processing error has occurred. The system will continue to run samples even when Relay 2 is triggered. The button will be highlighted in green when the relay is activated for this test.

Analog Output Calibration (Analog 0 or Analog 1)

To calibrate an analog channel, both the 4mA and 20mA output levels must be calibrated. See Figure 4.50.

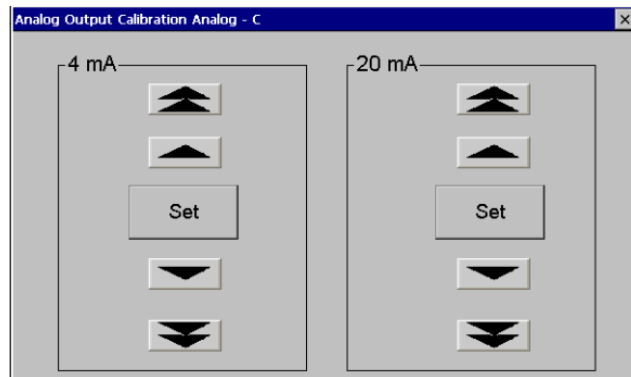

Figure 4.50 Analog Output Calibration Analog - 0

Start by calibrating the 4mA level, then calibrate the 20mA level, using the following steps:

- Click **Set** for the 4mA level and measure the output value.
 - If the value is less than 4.0mA, use the single or double-up arrows to increase the output value to 4.0mA.
 - If the value is greater than 4.0mA, use the single or double-down arrows to decrease the output value to 4.0mA.
- Click **Set** for the 20mA level and measure the output value.
 - If the value is less than 20.0mA, use the single or down-up arrows to increase the output value to 20.0mA.
 - If the value is greater than 20.0mA, use the single or double-down arrows to decrease the output value to 20.0mA.
- Click **Apply** to save the calibration.

Once both the 4mA and 20mA levels have been calibrated, the set feature can be used again to verify that the calibration is accurate enough to meet the system requirements.

NOTE: 4-20mA outputs and relay outputs can only be tested or calibrated when the 9220 system is in the standby state.

CO₂ Detector Screen

The CO₂ Detector screen displays built-in parameters for the CO₂ detector (Figure 4.51). Click the CO₂ Detector icon to view this screen.

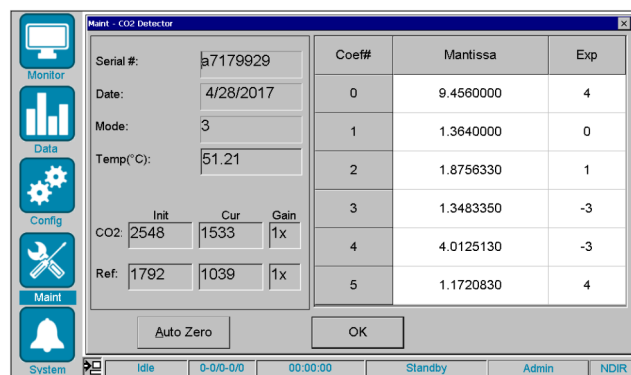

Figure 4.51 Maint - CO₂ Detector Screen

These values are read-only, as they are read directly from the NDIR detector itself.

The **Detector Serial Number** is provided as reference if the unit must be serviced or replaced.

The **Linearization Date** is provided as reference to know when this detector was factory linearized.

The **Linearization Mode** is for diagnostic purposes only.

The **Output Level values** (Init, Cur, Gain) for CO₂ and Ref channels are for diagnostic purposes only. If the Current (Cur) is below 1,000, this will result in NDIR errors.

The **NDIR Temp** (°C) shows the current temperature of the NDIR cell path. The default control value for the NDIR is 65.0 °C but can move upward with elevated ambient temperatures.

The **Coefficients 0 - 5 (Mantissa and Exponent)** are provided as reference to confirm against the factor coefficients calculated for this detector.

NOTE: *These coefficients are unique to every NDIR detector. If the detector is ever replaced, the new detector's values will automatically be read by the software upon rebooting the system. Although each NDIR detector is factory-linearized, the 9220 system must be recalibrated using current Method and Configuration settings for accurate sample analysis.*

The **Auto Zero Function** initiates an instant auto-zero process by which the NDIR performs a complete auto-ranging and then resets the baseline to 2000. The current NDIR output level will be adjusted to 2000 during the auto-zero process. This can only be performed in the standby state. This feature should only be used if the NDIR baseline has drifted significantly from the normal 2000 level.

Software Upgrades Screen

The **Maint** → **Software Upgrades** screen allows the operator to upgrade the 9220 user interface software and all of the internal board firmware programs. Software and firmware upgrades can be loaded onto a USB memory stick and downloaded onto the 9220 system using this screen.

To obtain upgrades for your 9220 system, contact Customer Support.

NOTE: *When working with USB memory sticks, always be sure to check the small LED light on the memory stick for activity before removing it. Some USB memory sticks will show a flashing LED light to indicate activity (i.e., reading or writing data), while others will show a solid LED light for activity. Some will show no LED light when inserted, while others will show a solid LED light when inserted. Be sure to test your USB memory stick to know its behavior. Do NOT remove a USB memory stick while activity is occurring, as this may result in data corruption on the device.*

To review and select from the available upgrades, insert the USB memory stick containing the upgrades into the USB port on the 9220 system. Then, select the **Software Upgrades** icon and the upgrade screen will appear (Figure 4.52).

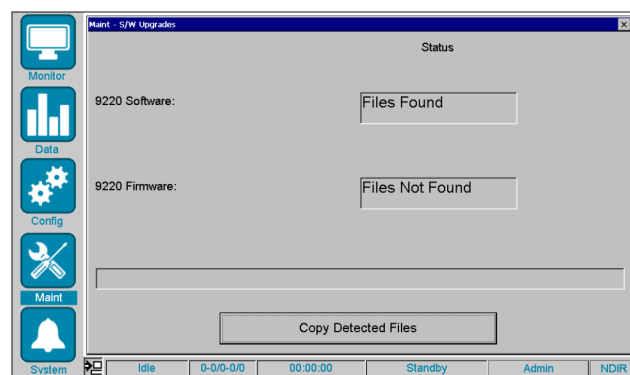

Figure 4.52 Maint - Software (S/W) Upgrades Screen

Select **Copy Detected Files** to begin the upgrade process. This process will take several steps to complete, most of which are automated. However, some operator intervention is required to reboot the 9220 system at certain points in the process. The basic upgrade process is as follows:

1. Upgrade files are copied from the USB memory stick to the 9220 device (Figure 4.53).

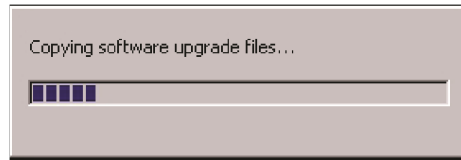

Figure 4.53 Copying Upgrade Files

2. The 9220 will need to be rebooted by the operator, after the USB memory stick is removed (Figure 4.54).

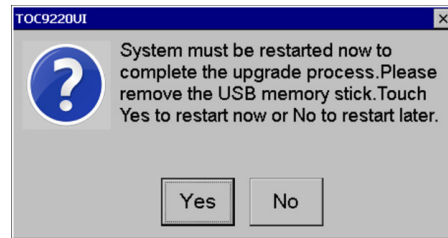

Figure 4.54 System Restart

3. The 9220 upgrade utility will display a progress screen and will automatically begin processing the upgrade (Figure 4.55).

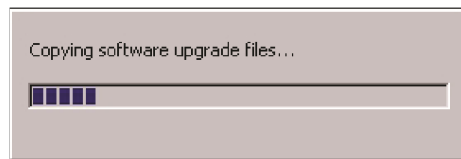

Figure 4.55 Upgrade Utility

4. The 9220 User Interface program will be upgraded (if needed; this may take 20-30 seconds).
5. The Main Pic Control board firmware will be upgraded (if needed; this may take up to 1 minute).
6. A progress bar will be displayed for each upgrade during the process.
7. Once the upgrades have been completed, the 9220 system will need to be rebooted again by the operator (Figure 4.56).

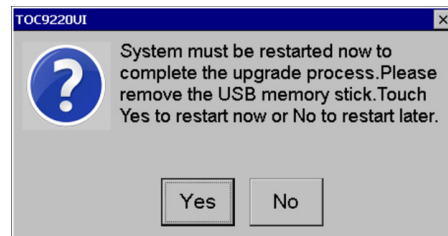

Figure 4.56 System Restart

8. The 9220 system will then begin its normal operations after the reboot occurs.

Once the upgrade has been completed and the 9220 system has been rebooted, the new software and firmware versions can be reviewed on the **Maint** → **System Diagnostics** → **System Info** screen.

Exit Screen

The Exit Screen provides the operator three choices as shown in Figure 4.57.

The Restart button will restart the 9220 software and bring the instrument back to the Standby mode.

The Shutdown button should be used before powering the 9220 OFF. After pressing the Shutdown button, the screen will fade to a white screen. It is now safe to power the 9220 OFF.

The ToDesktop button will cause the 9220 software to close and bring the operator to the Windows CE desktop.

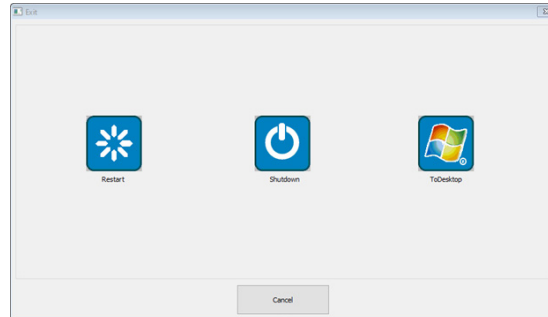

Figure 4.57 Exit Screen

4.7 Alarm Screen

Pressing Alarms opens the Alarm Log screen, which provides the operator the ability to see what alarms may have occurred, along with the ability to reset the alarms and clear the alarm log (Figure 4.58).

Pressing **Reset Alarm** will automatically reset all internal and external alarm conditions and relays.

Pressing **Clear Log** will clear the log display window but will not reset any alarm conditions and relays.

The **Prev** button will cause the five previous alarm log entries to be displayed.

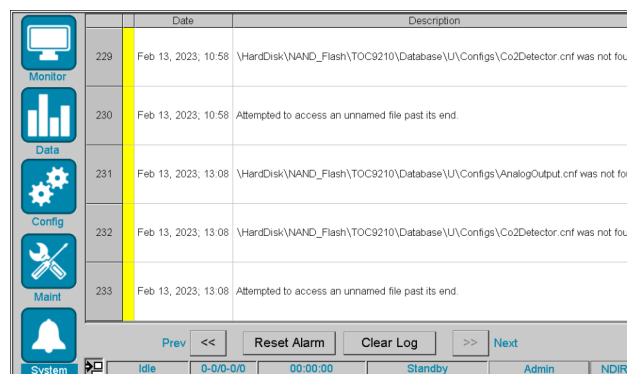

	Date	Description
229	Feb 13, 2023, 10:58	\\HardDisk\\NAND_Flash\\TOC9210\\Database\\UI\\Configs\\Co2Detector.cnf was not found
230	Feb 13, 2023, 10:58	Attempted to access an unnamed file past its end.
231	Feb 13, 2023, 13:08	\\HardDisk\\NAND_Flash\\TOC9210\\Database\\UI\\Configs\\AnalogOutput.cnf was not found
232	Feb 13, 2023, 13:08	\\HardDisk\\NAND_Flash\\TOC9210\\Database\\UI\\Configs\\Co2Detector.cnf was not found
233	Feb 13, 2023, 13:08	Attempted to access an unnamed file past its end.

Figure 4.58 Alarm Log Screen

The **Next** button will cause the five next alarm log entries to be displayed.

Color-coded icons indicate each message's severity. The blue icon represents an informational message, such as a sequence that was loaded or started. The yellow icon means a warning message, such as a concentration warning. The red icon indicates an error message, such as a hardware component failing to perform its task when first asked.

Double-clicking any alarm entry line will pop up the alarm details screen with more information about that alarm condition (Figure 4.59).

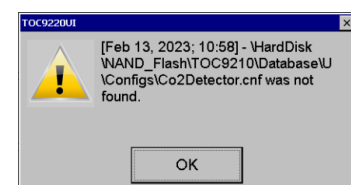

Figure 4.59
Alarm Log Detailed Description

5. 9220 Operation

This chapter provides information for operating the 9220 to analyze aqueous samples. Before starting the 9220, the operator should set up and install the instrument and all peripherals according to **Section 3: Installation**, and be familiar with the user interface presented in **Section 4: User Interface** section.

5.1 Introduction

The 9220 Analyzer comes standard with an integrated LCD touchscreen to serve as a standalone unit with direct access to instrument parameters and data. This manual describes the 9220 operations using the Windows CE computer and touchscreen controls. For a complete introduction to the user screens, refer to **Section 4: User Interface**.

5.2 Basic Overview of Components

To operate the 9220 TOC analyzer properly, a few basic steps must be taken to properly configure and run the system. These steps include:

1. Configure the 9220 (hardware-based and application-based parameters).
2. Calibrate the 9220 (based on the Method parameters defined).
3. Validate the calibration.
4. Define a continuous sampling sequence (based on sample ports installed).
5. Start the sequence.
6. Monitor the 9220 operations.
7. Monitor and manage the 9220 results data.

The following sections provide further details on these steps.

5.3 Configure the 9220 System

Once the 9220 TOC Analyzer and options have been properly installed, the operator must then configure the 9220 system for analysis. To do so, several parameters must be defined to match the hardware installed and to suit the specific application and sample matrix to be analyzed.

Configure the 9220 hardware-based parameters:

- Sample Introduction and Port Settings
- System Alarm Settings

Configure the 9220 application-based parameters:

- Analog Output Settings - for each sample port
- Sample Alarms Settings - for each sample port
- Method/Calibration/Validation Settings - for how to process the samples

Configure the 9220 Hardware-Based Parameters

Sample Introduction and Port Settings

Sample introduction refers to the hardware or process by which sample is drawn into the 9220 system for analysis. To configure the sample introduction parameters, open the **Config** → **Sample Intro** screen, and specify the following details on each of the tabs (Figure 5.1).

- Prime Volumes
- Timings
- Starts and Intervals

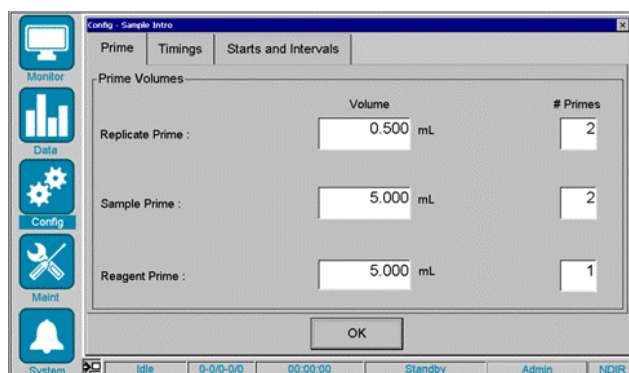

Figure 5.1 Config - Sample Intro: Prime, Sample Systems, and Starts and Delays Tabs

Once these configuration parameters are defined and tested for the 9220 system, they should not need to be changed unless a physical change in the instrument or sample system has been made, such as adding sample system valves, changing the location/distance of the sample to be acquired, or changing any “handshaking” between the 9220 system and any external control system.

For more information about the settings on this screen, refer to the **Config-Sample Intro** section of **Section 4: User Interface**.

System Alarm Settings

Open the **Config** → **Alarms** → **Relay 1 System Alarms** screen and specify which system events should be treated as errors and which should be treated as warnings (Figure 5.2).

If an event occurs for an event listed as an Error condition, Output Relay 1 will be triggered.

If the event is listed as a Warning, the relay will NOT be triggered.

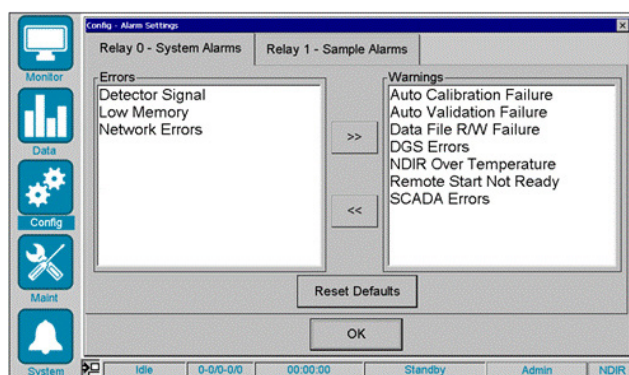

Figure 5.2 Config - Alarms - System Alarms

Configure the 9220 Application-Based Parameters

Analog Output Settings

The 9220 provides four (4) channels of 4-20mA analog output, which can be used to indicate either TOC sample concentration or sequence port number, depending on how they are configured by the operator. These Analog Output settings can be configured by accessing the **Config** → **Analog Output** screen (Figure 5.3).

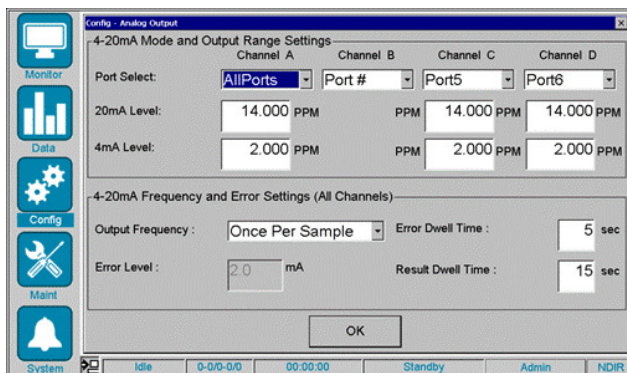

Figure 5.3 Config - Analog Output: Analog 0 and Analog 1

Select the **Port Select** for each channel to indicate which sample port (3-6) should be assigned to each channel (A-D). Then, specify the TOC concentrations (in ppm) for the 4mA and 20mA output levels. This feature allows the operator to configure a targeted working range for each sample port to match any system requirements that may exist for the site's data acquisition. This range should encompass the expected concentration range of samples to be analyzed on each stream. Sample concentration values that are outside of this range specified will be limited to the 4-20mA output range. For best accuracy, be sure to calibrate the 4-20mA outputs.

If Error Monitoring is required via the site's data acquisition system, select the frequency at which the 9220 should determine if an error has occurred. If an error level has been detected (as specified in the **Alarm Setting Screen** section of **Section 4: User Interface**), then the 9220 will toggle to the appropriate Analog output channel output, alternating between the calculated concentration value and the Error Level (2.0mA) to create a "square wave" style output that can be recognized by the plant's data acquisition system.

See the **Maint - Manual Controls - Analog** and **Config - Analog Output** sections of **Section 4: User Interface** for more details on these features.

Sample Alarm Settings

Open the **Config** → **Alarms** → **Relay 2 System Alarms** screen and specify which system events should be treated as errors and which should be treated as warnings (Figure 5.4).

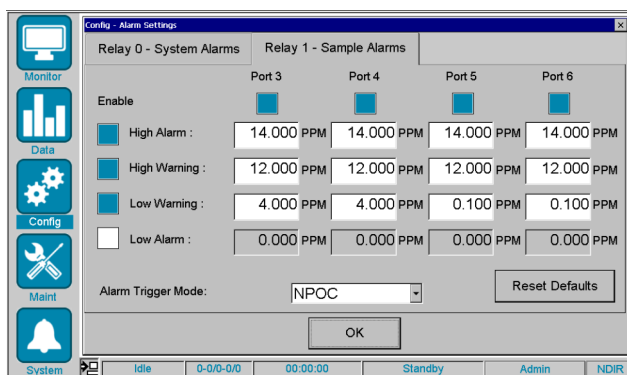

Figure 5.4 Config - Alarm Settings

To properly configure the system, Sample Alarms should be configured based on the expected concentration range of each sample to be analyzed.

These values will be used not only for Analog Outputs, but also to scale the individual channel trend chart displays on the 9220 system.

Finally, these values will be used to trigger the Error Toggle feature of the Analog Outputs, as well as to drive the LED-style alarm indicators on the Monitor screen.

Refer to the **Config-Alarm Settings** section of **Section 4: User Interface** for more details on these features.

Method/Calibration/Validation Settings

The Method Settings (including Basic, Calibration, and Validation) must be configured to suit the sample matrix application for the samples to be analyzed. This can be done via the **Config** → **Method Settings** screen (Figure 5.5).

NOTE: The 9220 only supports the concept of an “active” method. Methods are NOT named and stored to be recalled and used later.

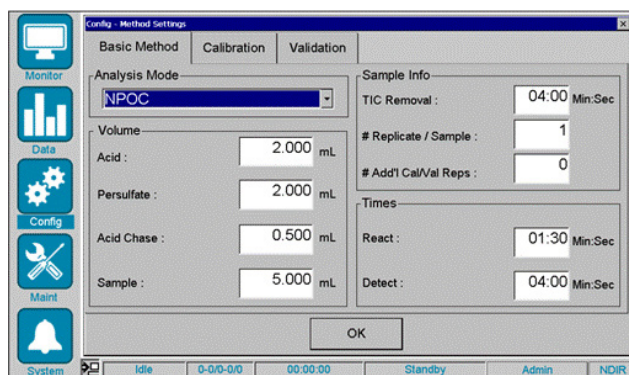

Figure 5.5 Config - Sample Intro: Prime, Sample Systems, and Starts and Delays Tabs

The Method Settings screen shows the expected analytical range of the method as specified via its calibration., the modes of analysis, the analysis times, reagent volumes, and other settings.

1. Define the Analysis Mode - NPOC

Sample and Acid are drawn into the Syringe chamber and sparged for a minimum time (TIC Removal time) with clean gas. The CO₂ released during sparging is vented to atmosphere. After sparging out the Inorganic/purgeable carbon, the sample is then transferred to the TC Reactor and persulfate is injected. During TOC React, the sample is heated to release the CO₂ from the organics into the headspace of the reactor. Then, in the TOC Detect state, the sample is sparged with carrier gas and swept to the NDIR detector, which measures the CO₂.

2. Define the Number of Replicates per Sample

The **# Replicates / Sample** field allows the operator to specify how many replicates of a sample must run each time a sample is analyzed. Replicates are used primarily for gathering statistical results for standards but can be used for samples as well. Since the exact concentration of process samples may be changing all the time, replicates may not provide much value to the site. Thus, the number of replicates is typically set to 1.

The **# Add'l Cal Replicates** field allows the operator to specify the number extra replicates that will be run when analyzing Calibration Standards. Since it is undesirable to have to repeat a calibration run due to calibration results being affected by potential carry-over from the “process” samples, these additional replicates are specified so that the system will automatically discard that many initial replicates at the start of the standard, and then only retain the final replicates for statistical purposes.

3. Define the Sample and Reagent Volumes

The Sample Volume defines how much sample is to be injected into the reactor analyzed. This volume should be configured to meet two basic goals:

- Provide enough sample volume for accurate and repeatable results.
- Limit the sample volume so as not to require excessive amounts of reagent and to not exceed the dynamic range of the detector.

The default 2.0mL of sample should be suitable for most applications up to 25ppm.

The **Acid Volume** to be used is more directly related to the amount of TIC that is present in the sample to be analyzed. The default of 0.5mL of 5% Phosphoric Acid should be able to easily remove up to 10ppm TIC in the sample, so as not to interfere with the TOC measurement. More acid may be required if higher TIC concentrations are present in the sample to be analyzed.

The **Acid Chase** volume is used to ensure a complete delivery of sample from the syringe into the TC Reactor, and to reduce possible carry-over when analyzing samples of varying concentrations. Typically, 0.2mL is sufficient.

The **Persulfate Volume** defines how much persulfate will be injected into the TC Reactor to oxidize each sample. Typically, 0.5–2.0mL are used for samples up to 25ppm. However, more difficult sample matrices may require more persulfate.

4. Define the TOC React and TOC Detect Times

The **React Time** is defined as the time where the TC Reactor is “closed” to the NDIR, and the sample is being heated and reacted (using the reagent) thus releasing the CO₂ into the headspace.

The **Detect Time** is defined as the time where the TC Reactor is “open” to the NDIR, and the sample is being sparged with carrier gas to sweep the CO₂ to the NDIR detector.

Typically, it is not necessary to change the TOC React or TOC Detect times when sample concentration is under 25ppm. However, more TOC React time may be required for higher concentrations or difficult to oxidize samples.

See the **Config - Method Settings** section of **Section 4: User Interface** for more details on these features.

5. Define the Calibration/Validation Range

The **Cal 1** thru **Cal 5** concentration values (in PPM) are used to define the expected range of the samples to be analyzed. At a minimum, two (2) calibration standards should be defined. The standards should be in increasing levels of concentration and should fully bracket the expected concentration range of all Sample Ports being measured (Figure 5.6).

NOTE: The calculated calibration results are reflected in the **Data → Calib** screen, which shows these set concentrations, as well as the reported area counts for these standards and the calibration statistics.

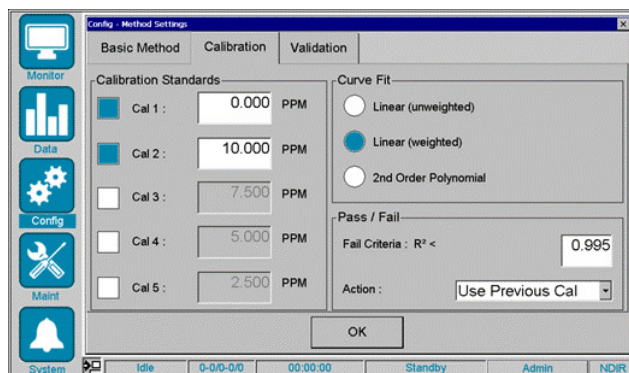

Figure 5.6 Config - Method Calibration Settings

The Cal 1 value is used to define the lowest concentration standard that will be analyzed for this Method.

The Cal [x] value is used to define the highest concentration standard that will be analyzed for this Method. That is, if a 2-point calibration is used, then Cal 2 will be the highest concentration. If a 3-point calibration is used, then Cal 3 will be the highest concentration, and so on.

NOTE: The 9220 will continue to report sample results for concentration values calculated to be outside of the range of the method calibration values defined. However, the results may be less accurate than those results within the range of the calibration.

NOTE: When changing calibration range, verify that the settings in the Config → Analog Output and Config → Alarms screens are still appropriate for the new calibration. Also, any changes in the Method Settings should be verified and calibrated prior to being used in an online monitoring situation.

The Val 1 thru Val 5 concentration values (in PPM) are carried over from Calibration screen. Here, the standards are selected to define which one(s) will be used to validate the accuracy of the calibration (Figure 5.6).

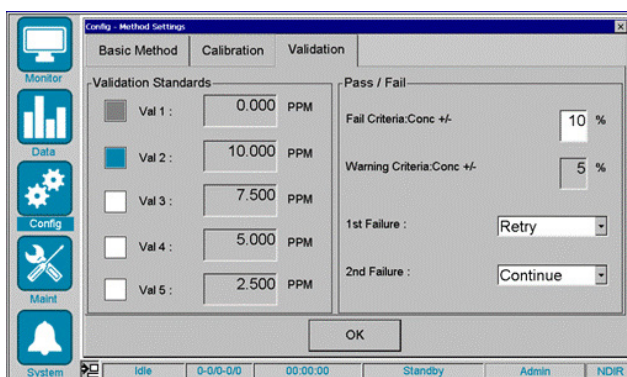

Figure 5.7 Config - Method Validation Settings

6. Optimize the Method Settings

The default settings provided for **Sample and Reagent Volumes** should be sufficient for typical sample analysis within the product specifications up to 25ppm TOC. However, some optimization can be archived depending on the sample matrix and expected concentration range.

For instance, if the 9220 system will be analyzing samples that are less than 1.0ppm TOC, then several parameters can be adjusted:

- First, the calibration range (highest standard) can be reduced from 25.0ppm down to 1.0ppm or 2.0ppm.
- With this reduced range, the operator can increase the volume of sample and reduce the volume of persulfate required to oxidize the sample.
- These changes will:
 - Increase the amount of carbon available to be analyzed for the sample while reducing the background contribution of the reagent,
 - Improve accuracy and precision of analysis for lower concentration samples
 - Reduce reagent consumption.

7. Calibrate the Method

A method must be calibrated before use. If a method is not calibrated and samples are processed, the computed mass of carbon and concentration are reported as zero (0).

See the **Calibrate the 9220 System** section below for further details on performing the calibration.

5.4 Calibrate the 9220 System

Once the 9220 TOC system has been properly configured, and the Method Settings have been defined to meet the sample application, the system then needs to be calibrated to these settings before it can be used to analyze process samples.

Liquid standards (typically KHP or equivalent) matching these concentrations will need to be prepared for the calibration analysis and placed at the sample ports defined in the sequence.

If this is the first time to run the 9220 system, or sample or configuration changes have been made, it is often desirable to run a few Cleanup samples to prepare the system for calibration. Below is a simple sequence with a Cleanup sample enabled. Figure 5.8

NOTE: Be certain that the Sample line is placed in de-ionized water (or equivalent) prior to starting the sequence. In this example, that would be the sample line for Port 3.

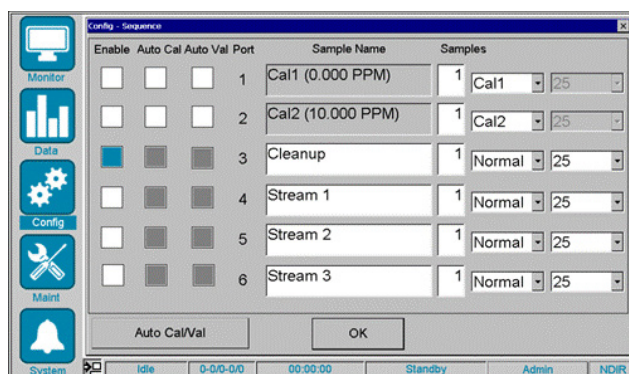

Figure 5.8 Config - Sequence - Cleanup

With this sequence defined, click the Start button and the 9220 will begin processing the "Clean Up" sample. Monitor the results of this sample to ensure that the system is clean and ready to calibrate.

Once the system is clean, the calibration can begin. This can be done without stopping the sequence. Simply enable both Calibration standards, and disable the Cleanup sample, and select OK (Figure 5.9).

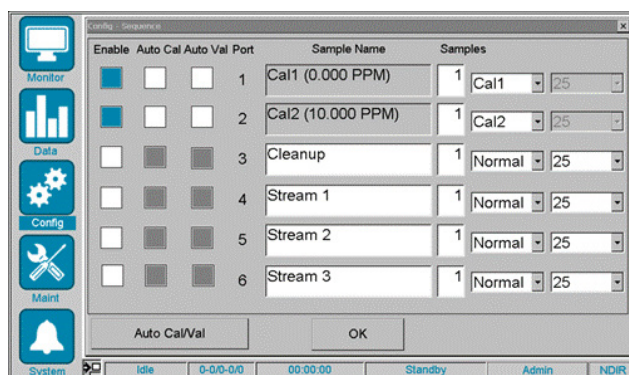

Figure 5.9 Config - Sequence - Calibration

After the 9220 acquires the last replicate of the Cleanup sample, it will automatically start sampling from port 1 to measure the Cal 1 (0 ppm) standard.

When the Cal 1 standard has been analyzed for all Replicates, the calibration data on the Data → Calibration screen will be updated to reflect the new RF and Offset for the calibration curve.

Once the Cal 1 standard has been completed, the Cal 2 standard has been analyzed for all Replicates. Again, once Cal 2 has been completed, the calibration data on the Data → Calibration screen will be updated to reflect the new RF and Offset for the calibration curve.

Alternate Calibration Process

The 9220 system can also be calibrated using samples that have already been analyzed. In this case, find and select the sample to be used for the calibration from the **Data Table** screen, double-click it, and select if this sample should be applied as the **Cal 1** or **Cal 2** standard. This will cause the 9220 to immediately recalculate the calibration data based on the standard applied.

For more information on this feature, refer to **Data - Data Table** section of **Section 4: User Interface**.

5.5 Validate the 9220 Calibration

Once the 9220 has been calibrated using the defined method parameters, the system should be validated to confirm that the performance is acceptable, prior to analyzing process samples.

Validation is performed much in the same way as calibration, where the user creates a simple sequence to run the validation standard(s). See Figure 5.10. These standards will use one (or more) the concentrations specified for the calibration standards.

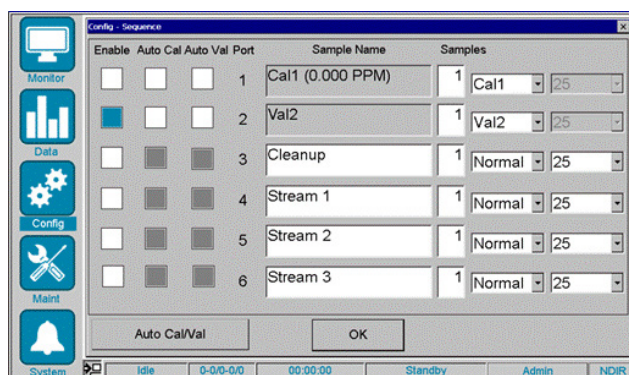

Figure 5.10 Config - Sequence Validation

Each Validation standard is processed in the same manner as Standards and Samples; however, the results are compared against the requirements specified in the **Method** → **Validation** page. Once validated, the system can be programmed for samples.

Calibration Calculations

Validation standards are used to verify analyzer performance. Samples of known concentration are prepared and analyzed. The computed results for validation standards are calculated in a slightly different manner from unknown samples. Specifically, for validation standards, the total area response is computed and then the Offset Area (from the calibration curve) is subtracted before multiplying by the calibration's response factor (RF) to determine the computed carbon mass and concentration. The equation is as follows.

$$\text{Mass C} = [\text{Computed area} - W] \times \text{RF}$$

Where:

- RF is the response factor of the computed calibration curve.
- W is the Offset Area (y-intercept) of the computed calibration curve.

Refer to **Section 11: System Calculations** for further details.

5.6 Define a Continuous Sampling Sequence

Once Calibration and Validation have been completed, the 9220 system is ready to run continuous samples. To continuously analyze samples, a sequence must first be defined. Once a sequence is started it will run continuously, until it is manually aborted, or a system error occurs.

When defining a sequence, the 6-Port Sample System hardware installed must be considered. This will define which samples are assigned to each port on the valve.

A typical sequence used to analyze multiple samples from multiple sources (using multiple ports on the 6-Port Sample System) could look like the following sequence (Figure 5.11).

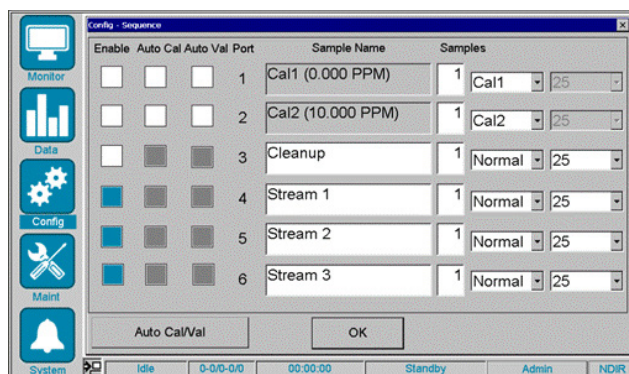

Figure 5.11 Config - Sequence: Multiple Sources

In this example, the 9220 would begin processing the "Stream 1" sample (using Port 4), then progress to the "Stream 2" (using Port 5), and "Stream 3" (using Port 6), automatically switching the valve to the appropriate port as needed. Once the "Stream 3" sample completed, the process would start over with "Stream 1" and run continuously.

If additional sample streams are to be sampled, they can be added at any time by assigning and enabling a port for those samples.

5.7 Start the Continuous Sequence

Reviewing the Pre-Start Checklist

Before a sequence is started, the operator should always verify the 9220 system is ready for operation. Use the pre-start checklist below to confirm the following:

NOTE: If the system is new or has been idle for more than a few days, consider performing a Safe Start macro first. See System Macros in **Section 4: User Interface**.

- System is properly configured for System, Method, and Alarm parameters.
- System is properly calibrated/validated.
- External hardware is functioning properly (PGM, Sample Valves, etc.)
- System is properly connected to a zero-pressure floor drain, or receptacle.
- Sequence is properly defined for samples (and ports) to be analyzed.
- Samples are available at the sample port(s) to be analyzed.
- Reagent containers have been filled (both Acid and Persulfate)
- No error or warning indicators are lit on the monitor screen.

Starting the Sequence

Once the pre-start checklist has been verified, the 9220 sequence can be initiated by using the Start button on the monitor screen (Figure 5.12).

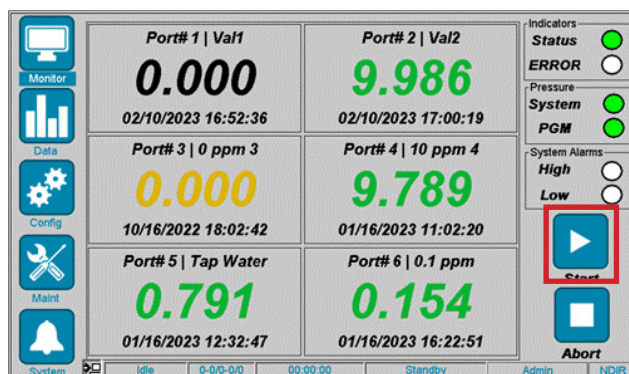

Figure 5.12 Start Button

When the Start button is pressed, the 9220 system will automatically verify several key parameters to confirm that the system is ready to begin processing samples. If any condition issues exist, the operator will be prompted with a message indicating what needs to be addressed. Otherwise, the 9220 system will immediately begin processing the sequence.

At the start of a sequence, the 9220 will automatically prime both the acid and persulfate reagents, as well as drain the TC Reactor, to ensure proper operating conditions to start the sequence.

Once this is completed, the system will start processing the first sample in the sequence, starting with Port 1 (if defined) and advancing toward Port 6.

Adding Priority Samples to the Sequence

If a "priority" sample needs to be processed, it can be added at any time to the sequence (Figure 5.13). Define the name of the sample, specify the sample as a Priority type, click the Enable checkbox, then click OK.

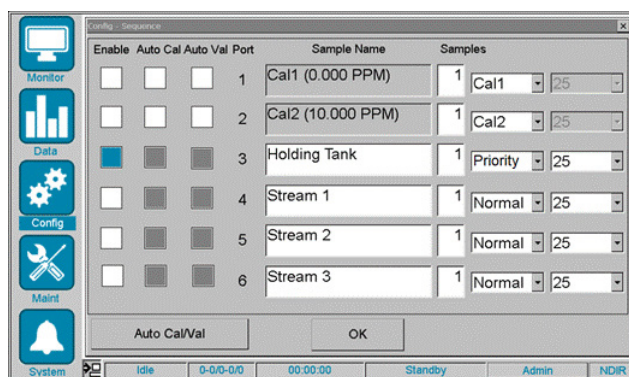

Figure 5.13 Config - Sequence: Priority Sample

The 9220 will automatically advance to the Priority sample on a "first available" basis. This means that the 9220 will first finish all replicates of the current sample being processed, and then advance directly to the Priority sample.

Once analyzed, the priority sample will automatically be disabled, and the 9220 system will return to processing its normal sequence.

Aborting the Sequence

Once the sequence has been started, it will run continuously, unless it is either manually aborted by the operator (or a remote connection) or it encounters a serious System Error.

In the event of an abort, the system will immediately terminate processing of any samples, and return to the standby state.

NOTE: Once aborted, the sequence cannot be resumed where it left off. It will restart from Port 1, unless ports are manually disabled to skip certain samples, and then enabled again after the sequence is started.

5.8 Monitor the 9220 Operations

Once the 9220 system has been started, basic status and operation information about the 9220 analyzer is presented on the monitor screen and the status bar at the bottom of the window. The system operations can be monitored via several different screens.

The Monitor Screen

The main Monitor screen shows several pieces of important information (Figure 5.14).

- The most recent results data for each channel
- Key indicator and warning/error LEDs
- Main status bar for system progress, timings, and status

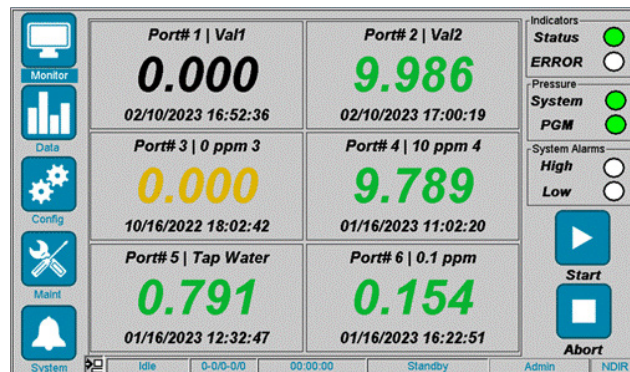

Figure 5.14 Run Mode Screen

Run Log Screen

Press Maint → Run Log to view the Run Log screen, which displays a tabular view of the most recent 300 messages posted to the log (Figure 5.15). Messages fit into three categories: informational, warning, or error. Pressing Clear Log and acknowledging the confirmation message permanently clears the log.

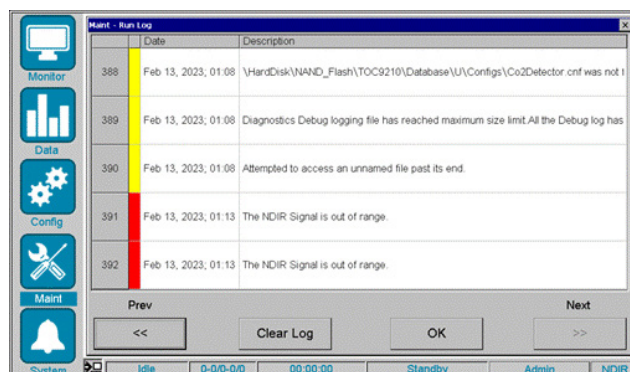

Figure 5.15 Maintenance Run Log Screen

Alarms, Relays, and Analog Outputs

The 9220 can signal a concentration alarm on a once-per-sample or once-per-replicate basis. Also, the analog outputs and can be configured to signal result concentration, with operator-specified minimum and maximum ranges. For details on setting up this interface, refer to **Analog Output Settings** in **Section 4: User Interface**.

Every 9220 ships with two built-in output relays. One serves as a System Error relay, signaling to remote sensors that a system error has occurred. The other serves as a Concentration and Alerts relay, indicating that the system has encountered some sample related issues. For details on setting up this interface, refer to **Alarm Settings** in **Section 4: User Interface**.

Reviewing the Alarm Log

The Alarm Log screen provides information about the status of the instrument and what problems may have occurred while processing has been performed.

5.9 Monitor and Manage 9220 Sample Results Data

In addition to monitoring the operational status of the 9220 system, it is important to monitor and manage the data produced and collected by the 9220.

As each sample is completed, the data calculated will be posted to several locations, as follows:

- Monitor screen - Main display panels
- Monitor screen - Port-based data table and trend graphs
- Data screen - Table view, trend view, and calibration table for all Ports/Samples (includes on-board storage up to 50,000 samples)
- Analog Output - 4-20mA signals for up to 4 sample ports

Monitor Screen

The main Monitor screen shows the latest value for each active sample in the sequence. Each display panel includes the Port number, Sample name, most recent TOC value, and the Date/Time of that most recent value (Figure 5.16).

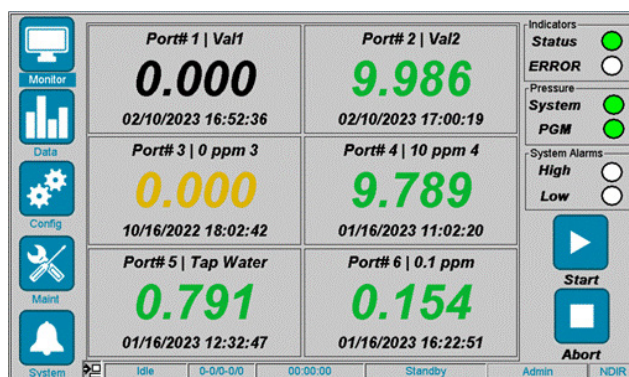

Figure 5.16 Run Mode Screen

The color of the data value text for each Port/Sample indicates if that data value is in or out of the data range defined for that channel. Refer to **Section 4: User Interface** for more details.

Data Screen - Table and Trend Views

Press **Data** → **Table View** icon to view the Data Table screen (Figure 5.17). It provides a tabular display of results for the entire data set (all samples, in chronological order) that is stored on the 9220 system. The table of results will remain available until it is archived and removed manually...or until 10000 samples have been stored, at which time the oldest samples will be replaced by the newest, in a FIFO (first-in, first-out) fashion.

NOTE: The 9220 will continue to store up to 50,000 samples, but only the most recent 10,000 samples can be displayed.

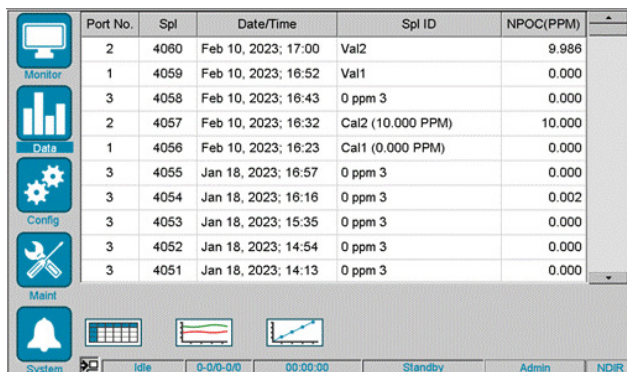

Port No.	Spl	Date/Time	Spl ID	NPOC(PPM)
2	4060	Feb 10, 2023; 17:00	Val2	9.986
1	4059	Feb 10, 2023; 16:52	Val1	0.000
3	4058	Feb 10, 2023; 16:43	0 ppm 3	0.000
2	4057	Feb 10, 2023; 16:32	Cal2 (10.000 PPM)	10.000
1	4056	Feb 10, 2023; 16:23	Cal1 (0.000 PPM)	0.000
3	4055	Jan 18, 2023; 16:57	0 ppm 3	0.000
3	4054	Jan 18, 2023; 16:16	0 ppm 3	0.002
3	4053	Jan 18, 2023; 15:35	0 ppm 3	0.000
3	4052	Jan 18, 2023; 14:54	0 ppm 3	0.000
3	4051	Jan 18, 2023; 14:13	0 ppm 3	0.000

Figure 5.17 Data - Table View

Use the slider bar on the right side to navigate through the data in this table.

Press **Data** → **Trend View** icon to view the Data Trend screen (Figure 5.18). This Trend View shows the same data as the Table View, only in a graphical format for easier trending analysis (Figure 5.18).

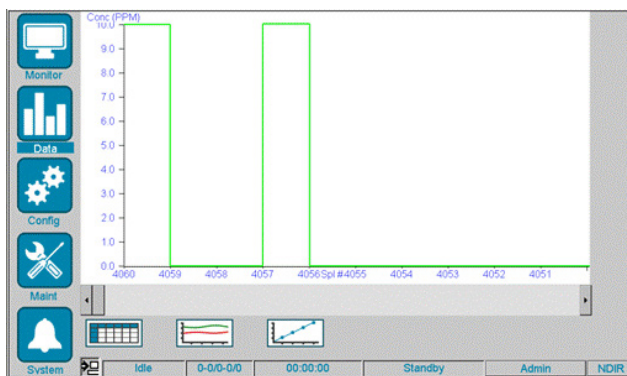

Figure 5.18 Data - Trend View

This Trend View will automatically stay synchronized with the Table View whenever the slider bars are used on either screen. That way, the operator can easily switch back and forth between views as needed.

As with the Table View, the data in this display will stop refreshing whenever the slider bars have been used to view older data. To resume refreshing with the most recent data, use the slider bar again to show the most recent data.

Refer to the **Data** screen section of **Section 4: User Interface** for more information.

Monitor → Port Data → Table, Trend, and Statistics Views

From the main Monitor screen, click on one of the six sample data panels to see the data for just that port (sample).
 Port Data → Table View icon to view the Data Table screen for the selected port (Figure 5.19).

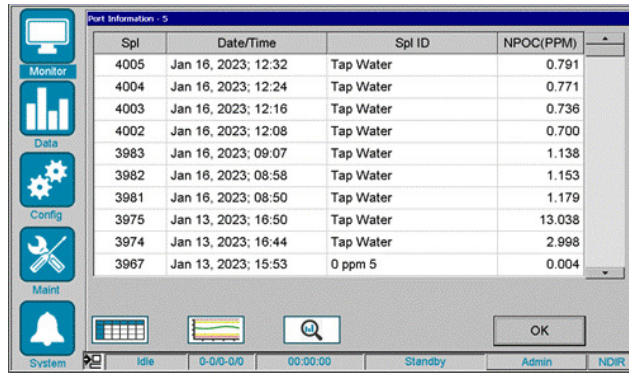

Figure 5.19 Port Data - Table View

Click on the Port Data > Trend View icon to view the Trend Graph screen for the selected port (Figure 5.20).

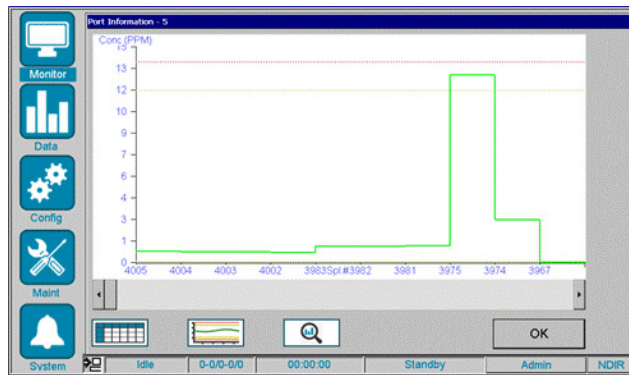

Figure 5.20 Port Data - Trend View

This display will also include the High/Low Error and Warning limit-level lines, as defined for this Port/Sample.

Click on the Port Data → Statistics icon to view the Statistics screen for the selected port (Figure 5.21).

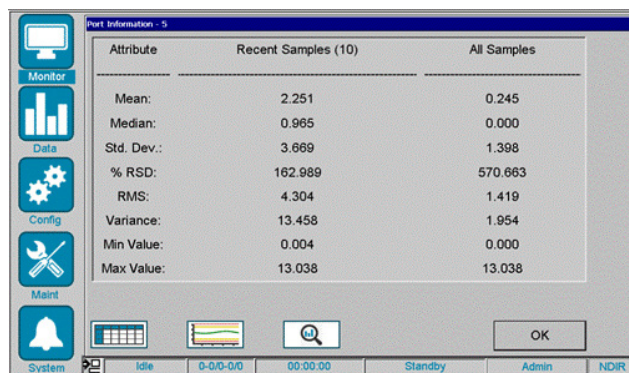

Figure 5.21 Port Data - Statistics

NDIR Detector - Real-Time Peak Graph

When configuring or troubleshooting problems with the 9220 system, it may be helpful to see the real-time peak graph from the detector (Figure 5.22). For details on how to use this feature, refer to **Detector Screen in Section 4: User Interface**.

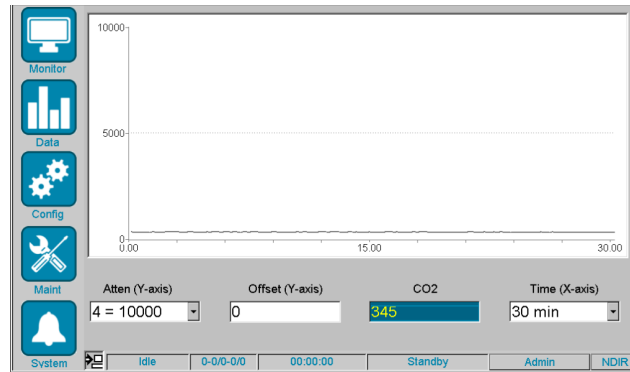

Figure 5.22 Real-Time Peak Graph

6. Maintenance

This chapter contains tables outlining user maintenance required for proper operation of 9220 Online TOC Analyzers.

6.1 General System Maintenance

Maintenance Item	Frequency	Task
Check Acid Reagent	Every 2-3 weeks, depending on method settings and sampling frequency	Refill Acid reagent container, as needed (OI P/N 326244)
Check Persulfate Reagent	Every 2-3 weeks, depending on method settings and sampling frequency	Refill Persulfate reagent container, as needed (OI P/N 326243)
Check Carrier Gas (PGM canister)	As needed; check CO ₂ -scrubber media weekly (verify at least 1" layer of white color media exists)	Replace CO ₂ -scrubber media, as needed (OI P/N 327308)
Check Sample System (and filtration)	Verify sample flow rate and volume is sufficient for analyzer; (if user supplied filter is installed, verify filter is not clogged)	Correct sample flow rate or replace sample filter, as needed
Verify File Storage Space	Monthly, or as needed	Use Maint → System Diagnostics → File System to verify free space is >10,000
Archive Data	Monthly, or as needed	Use Maint → Data Storage feature to archive and clear data

Table 6.1 Fluid and Gas Supply Maintenance

6.2 Routine Inspections

Maintenance Item	Frequency	Task
Verify Sample Calibration	Monthly	Use validation samples to verify system is properly calibrated; re-calibrate as needed
Verify Analog Outputs	Monthly	Verify analog outputs; recalibrate as needed
Verify Fittings and Tubing	Monthly	Verify all tubing is leak-free and undamaged; verify all fittings are tight and leak free
Verify Reactor is Draining	Monthly	Verify that the TC Reactor is draining completely at the end of each sample replicate
Verify 6-Port Valve is Rotating	Monthly	Verify the internal 6-port valve is rotating during the load sample or transfer sample states
Verify Persulfate Pump	Monthly	Verify the pump is injecting liquid during the inject state; verify no bubbles in the Persulfate lines or leaks at unions
Verify Drain Tubing	As needed	Verify drain tubing is not blocked or below the level of the liquid in the drain
Verify Vent Ports are Not Blocked	As needed	Verify the NDIR Vent and the Waste Vent ports are not plugged or restricted
Verify System and PGM Pressures	As needed	Verify the system pressure and PGM pressure are within range

Table 6.2 Routine Inspections

Maintenance Item	Frequency	Task
Verify Syringe is Leak Free	Monthly	Inspect for liquid above syringe tip plunger; Inspect for liquid around bottom of seal/o-ring
Verify TC Reactor is Leak Free	Monthly	Inspect for liquid leaks around glassware and all fittings
Verify Peak Shapes	Monthly	Verify TOC peaks look Gaussian in shape, with minimal tailing or double peaking
Verify NDIR Baseline Signal	Monthly	Verify NDIR baseline signal (when not in detect) is within 1800-2200 range
Verify NDIR Temperature	Monthly	Verify NDIR temperature is 45 °C after warm-up
Verify System Date/Time	Monthly	Verify date/time is correct, adjust as needed
Check for Corrosion	Monthly	Check all metal components for corrosion, clean or replace as necessary
Verify System Flow Rate	Monthly	Measure system flow rate at NDIR Vent (during detect) is 65mL/min (± 7.0)

Table 6.2 Routine Inspections

6.3 Additional Maintenance

Maintenance Item	Frequency	Task
Perform System Archive	Monthly	If system method or configuration settings have changed, perform a system archive
Check PGM Option Components	Monthly	<ul style="list-style-type: none"> • Replace CO₂ scrubber media as needed • Replace air filter as needed • Empty water from air filter canister as needed • Replace optional charcoal filter as needed
Check Sample Loop(s)	Monthly	<ul style="list-style-type: none"> • Verify sample loops are not leaking and are properly filling with fresh sample each time • Verify nothing is growing on loop (clean as needed)
Check 6-Port Sampler Components	Monthly	<ul style="list-style-type: none"> • Verify 6-Port valve is selecting proper port position • Verify optional sample valves on Ports 3-6 are actuating as needed • Verify there are no leaks

Table 6.3 Additional Maintenance

6.4 Syringe Plunger Inspection and Replacement

1. Perform the following steps to inspect and/or replace the Syringe Plunger.
2. Make sure that the TOC 9220 is in the "Idle/Standby" state or is powered off.
3. Disconnect the blue tubing fitting from the bottom of the Syringe Assembly.
4. Unscrew and remove the barrel of the Syringe Assembly and remove the syringe bottom.
5. Remove the glass cylinder by sliding it straight down, or by sliding it down while twisting slightly (counterclockwise), and off of the syringe plunger.

NOTE: Clean and dry the glass cylinder if necessary.

6. Unscrew the syringe plunger clockwise to remove. Hold the upper plunger section on the actuator shaft in place to prevent it from turning, if necessary.
7. Install new syringe plunger, and hand-tighten.
8. Slide the new glass cylinder back up onto the syringe plunger, twisting it slightly (counterclockwise), until it stops against the top section of the syringe assembly.
9. Replace o-ring in syringe bottom.
10. Make sure that the syringe bottom is seated into the bottom of the syringe barrel and tighten it back onto the syringe assembly.
11. Reconnect the blue tubing fitting (from the Six-Port System Valve Assembly) back into the bottom of the Syringe Assembly.
12. Perform a "Safe Start" or reboot the 9220 to re-home the Syringe Assembly.

NOTE: During the first upstroke of the syringe, completely tighten the syringe barrel.

6.5 Tubing and Fitting Inspection and Replacement

Perform the following steps to inspect and/or replace the tubing and fittings:

1. Make sure that the TOC 9220 is in the "Idle/Standby" state or is powered off.
2. Inspect all tubing and fittings carefully, looking for cracks, leaks, or other damage. Also inspect for any residue or build-up in the tubing. Replace as needed.
3. If replacing 6-port valve tubing, replace each tube individually, as needed, noting the port number connection and the final destination of each tube.
4. Perform a complete leak-check procedure after any tubing has been replaced.

6.6 Check Valve Inspection and Replacement

Perform the following steps to inspect and/or replace the check valves.

1. Make sure that the TOC 9220 is in the "Idle/Standby" state or powered off.
2. Inspect all check valves carefully, looking for cracks, leaks, or other damage. Also inspect for any residue or build-up in the tubing around the check valve. Replace as needed.
3. Replace the check valve as needed.

6.7 Data Archiving

Be certain to archive any results data and perform a system file archive at least once a year. To do so, the system must be in the "Idle/Standby" state. Refer to **Section 4: User Interface** for details on performing this procedure.

7. Troubleshooting

This chapter provides a list of problems that may occur when operating the 9220 along with probable causes and recommended corrective actions. The probable causes of each symptom appear in order of increasing severity. Before using this guide, become thoroughly familiar with the operation and maintenance information contained in previous chapters.

7.1 Basic Troubleshooting

Symptom	Possible Cause	Corrective Action
Error LED is red	<ol style="list-style-type: none"> 1. Temperature error 2. Pressure Error 3. Communications Error 	<ol style="list-style-type: none"> 1. Check all temperature zones for proper operation. 2. Check System and PGM pressures. 3. Verify all cable connections.
Alarm LED high/ low is yellow or red	<p>If yellow, one or more sample concentration warnings (sample reading exceeds warning setting).</p> <p>If red, one or more sample concentration errors (sample reading exceeds error setting).</p>	Verify sample and reagent levels; verify NDIR detector baseline is stable and within expected range; verify PGM scrubber media is still active and effective; verify method settings.
TOC readings too high	Out of acid (in high TIC sample)	Refill acid bottle, verify it is not leaking, and properly re-prime.
	Bad (contaminated) reagent	Replace reagent and bottle.
	Contaminated sample or fill-n-spill loop	Confirm sample quality; clean sample loop as needed.
	PGM scrubber media failure	Check PGM media indicator color; replace PGM scrubber media as needed.
	TE cooler failure	Verify TEC temperature and connector. Replace TEC module if needed.
	Insufficient TIC removal time (in NPOC mode)	Correct method settings to increase TIC removal time or acid volume.
	Improper method settings	Adjust reagent/sample volumes or time settings.
	Change in TOC concentration level	Verify process sample for contamination; run lab test sample to confirm.
	Low gas pressure	Verify system pressure is 13psi \pm 1.0psi.
	TOC reactor not draining properly	Verify gas pressure; verify drain line is not full; verify V1 and V2 valve working.
Microbial growth in tubing or reagent bottles	Clean or replace any tubing or bottles that show signs of growth.	

Table 7.1 Basic Troubleshooting

Symptom	Possible Cause	Corrective Action
TOC readings too low	Out of persulfate	Refill bottle and reprime pump. Confirm no bubbles in tubing.
	Low sample volume / Out of sample	Correct sample flow or plumbing issues.
	Bad (contaminated) reagent	Replace reagent.
	Contaminated sample/loop	Check/replace sample loop as needed.
	Out of carrier gas	Verify cylinder/regulator; verify PGM (if used).
	Syringe failure	(see syringe error)
	Valve failure	(see valve errors)
	TE cooler condenser level too low	Perform Safe Start macro; confirm filled to bottom part.
	TE cooler failure	(see above)
	Improper method settings	(see above) Too little persulfate
	Loose fitting/Fluid leak	Verify and tighten all fittings; check for tubing damage or leaks.
	TC reactor heater failure	Verify heater on Maint → Manual Controls.
	Persulfate pump or check valve failure	Verify pump is working with no leaks in tubing or check valve; replace as needed.
	TOC reactor not draining properly	Verify gas pressure; verify drain line is not full; verify V1 and V2 valve working.
TOC reading fluctuating	Insufficient TIC removal (for sample with high TIC content)	(see above)
	TC reactor heater control issues	(see TC reactor error above)
	NDIR heater control issues	(see NDIR heater error)
	TEC cooler control issues	(see above)
Analog output error	Improper alarm settings for sample range/type	Correct settings as needed; verify 4-20mA calibration.
	4-20mA connection wiring and/or power issue	Verify connection; verify 4-20mA calibration.
System aborted	System error occurred, or system manually aborted by operator	Check status and error LEDs and alarms log for detailed information about the error, review errors in Basic Troubleshooting guide.
Alarm log errors	System errors or warnings	Review errors in Basic Troubleshooting guide.

Table 7.1 Basic Troubleshooting

Symptom	Possible Cause	Corrective Action
System pressure error	System pressure not at 13psi ± 1.0psi	Verify PGM pump is working (and PGM canister is not leaking or clogged).
		Verify gas is flowing at inlet fitting on 9220.
		Verify gas lines are not damaged or leaking.
		Verify EPC Valve is working (and not leaking).
PGM pressure error	PGM pressure not in range of 15-17psi limits	Verify PGM pressure on Maint screen.
		Verify PGM pump is working.
		Verify gas lines are not damaged or leaking.
		Verify PGM canister o-ring is installed and not leaking.
		Verify gas is flowing at inlet fitting on 9220.
Syringe error	Syringe actuator failure or syringe home sensor failure	Verify syringe operation by performing Safe Start macro.
		If syringe fails to move, syringe actuator may be damaged or jammed.
		If syringe fails to find "home" (i.e., grinds) at top of travel, home sensor may require adjustment (turn screw clockwise).
		Verify and replace syringe assembly as needed.
		In the electronics compartment, inspect the end connectors on all ribbon cables and ensure they are fully seated.
		In the electronics compartment, inspect the 7-pin connector from the syringe actuator cable and ensure that it is connected to the Main PIC board.
6-Port System Valve error -or- 6-Port Sample Valve error	Valve actuator failure	Verify 6-port valve operation by performing changing ports in the Maint → Manual Controls screen; listen for rotation when changing ports.
		Verify and replace valve assembly as needed.
		In the electronics compartment, inspect each 6-port valve cable and ensure that it is connected to the main board.
2-way or 3-way valve error	Valve actuator failure or valve blockage	Verify valve operations by toggling on/off in the Maint → Manual Controls screen; listen for valve "click" for V1 through V5 valves.
		Verify and replace valves as needed.

Table 7.1 Basic Troubleshooting

Symptom	Possible Cause	Corrective Action
Carrier flow at NDIR vent is too low in detect	TEC condenser obstructed or tubing/fitting leak	Inspect TEC condenser for obstructions and check tubing/fittings for leaks.
	System pressure low	(see system pressure error)
	V1 or V2 valve failure or obstruction	Verify V1 and V2 valve operations; replace if needed.
	Tubing loose or obstruction from valve manifold to NDIR detector	Verify all tubing from valve manifold to NDIR detector; inspect for loose fittings or damaged tubing.
TC reactor heater error	Heater fails to maintain set point during TOC react or TOC detect	Verify heater temperature on Maint → Manual Controls screen; verify connectors are properly engaged; replace heater assembly as needed.
NDIR heater/ temperature error	Heater fails to maintain minimum 45 °C set point, or exceeds maximum temperature	Verify NDIR temperature on Maint → CO ₂ detector page.
		If temperature is below 30 °C when the 9220 has been on for at least 30 minutes, the NDIR heater may have failed; repair/replace NDIR as needed.
		If NDIR temperature is above max temperature, and ambient temperature is less than 45 °C, the heater control may have failed; repair/replace NDIR as needed. If ambient temperature is above 45 °C, the 9220 unit is being used out of specified ambient temperature range.
Heater error (general)	Heater fails to maintain set point within allowable range	Verify heater connections; replace heater assembly as needed.
System abort during power-up	System fails to properly complete the power-up state after a power cycle	Confirm system pressure and gas supply and correct as needed. Confirm Syringe drive moved and properly found Home position.
NDIR signal error	NDIR signal value has fallen below the minimum value (0) , or has risen above the maximum value (65535); gas pressure or gas quality issue	Confirm the NDIR signal value in the Maint → Manual Controls → Detector screen.
		If signal is above the maximum value, and in a detect state, then the peak exceeds the detector range. Dilute sample or adjust method parameters reduce peak size.
		If signal is below the minimum, abort the sequence and perform an Auto-Zero in the Maint → CO ₂ Detector screen. If this problem persists, repeat the Auto-Zero up to two more times. Contact service if the problem persists.
Main Pic polling error	Power or communication failure with Main Pic board	Check all electrical and communication connections; cycle power to 9220 system; re-flash program onto board; replace board if needed.
NDIR polling error	Power or communication failure with NDIR board	Check all electrical and communication connections; cycle power to 9220 system; re-flash program onto board; replace board if needed.

Table 7.1 Basic Troubleshooting

Symptom	Possible Cause	Corrective Action
6-Port Sample Valve error	Power failure with 6-port sampler valve	Check all electrical connections to the Sample Valve; cycle power to 9220 system
LCD display error	LCD or backlight failure, or possible power failure	<ol style="list-style-type: none"> 1. Confirm that the GUI Display Module Power (blue) LED is lit. 2. Power cycle the 9220 unit and confirm that the 9220 begins the user Power-Up steps, including homing the syringe. 3. If power-up steps occur, then the LCD or backlight may be bad. 4. If power-up steps do not occur, confirm power lights are being lit on the circuit boards in the upper electronics enclosure. 5. If no lights are on, then there is likely a power supply problem. 6. If the power lights are on, then it may be a problem with the GUI Display module. Contact service.
Touchscreen not responding	Possible touchscreen interference or failure, or software lockup	Confirm touchscreen is not being impinged by the surrounding bezel or other mechanical interference. Power cycle the 9220 unit. If problem persists, contact service.
Device software error	Device software does not appear after a power cycle	Possible corrupt file; contact service for re-installation software; use Restore feature to recall previously archived files.
Corrupt file error	A configuration or data file cannot be properly opened or saved	If a file is corrupted, the Restore feature can be used to replace corrupted configuration files with previously archived files. Refer also to internal drive error.
Internal drive error	Internal drive capacity may have been exceeded or drive has become corrupted	Check the Free space on the Maint → System Diagnostics → File System screen. If less than 10,000, abort the sequence, and free up disk space by performing an “Archive Results to USB Memory Stick” with the “Archive without Removing Data” checkbox unchecked. If problem persists, contact service.

Table 7.1 Basic Troubleshooting

7.2 9220 Plumbing Diagram

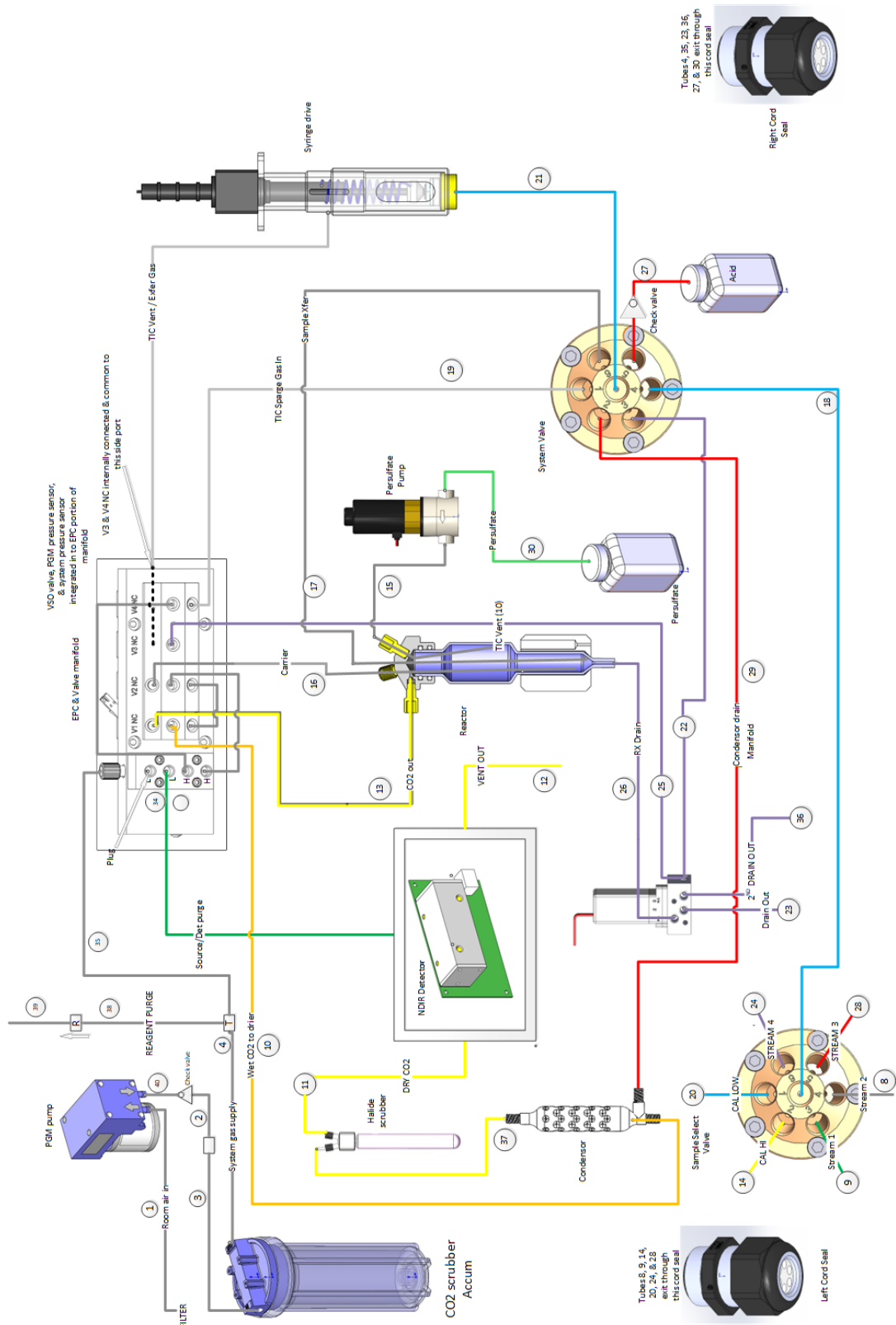

Figure 7.1 9220 Plumbing Diagram

8. Equipment Options



This chapter provides information on optional equipment and accessories available for installation and operation the 9220 Online TOC Analyzer.

Option	Part Number
Process Gas Options	
KIT-CO2 SCRUBBER 1KG 9220	327308
KIT-ZERO AIR FILTER ASSY	327900
Rack Options	
KIT-PANEL MOUNT 9220	326757
Sample System Options	
KIT-SAMPLE INLET SYSTEM 9220	327114
KIT-SS EXT SAMPLE VLV 9220	326814
KIT-BR EXT SAMPLE VALVE 9220	326389

Table 8.1 Options Available for the 9220 Online TOC Analyzer



Process Gas Options		
Option	Image	Part Number
<p>Kit-CO₂ Scrubber 1kg 9220 - This kit provides a 1kg canister (4-6 month supply) of CO₂ scrubber media for use in the 9220 Process Gas Module</p>		327308
<p>Kit-Zero Air Filter Assy - This kit provides an adapter and activated-charcoal filter for removing airborne contaminants for use with the 9220 Process Gas Module.</p>		327900

Table 8.2 Process Gas Options



Sample System Options		
Option	Image	Part Number
<p>Kit - Sample Inlet System 9220 - This sample inlet loop option is utilized to create a low-pressure sampling source for the 9220 analyzer. It can be used with an External Sample Valve (326389 or 326814) to reduce sample consumption, or without a valve for a free-flowing sample.</p>		327114
<p>Kit - SS Ext Sample VLV 9220 - This stainless-steel external valve kit is used in conjunction with the Sample Inlet System (327114) to reduce sample consumption. The 9220 has built-in control for one of these external valves or can control up to four of these external valves when used with a 6-Port Sample System (327356).*</p> <p>*Selection of brass or stainless steel is application dependent.</p>		326814
<p>Kit - Br Ext Sample Valve 9220 - This brass external valve kit is used in conjunction with the Sample Inlet System (327114) to reduce sample consumption. The 9220 has built-in control for one of these external valves or can control up to four of these external valves when used with a 6-Port Sample System (327356).*</p> <p>* Selection of brass or stainless steel is application dependent.</p>		326389

Table 8.4 Sample System Options

9. Replacement Parts

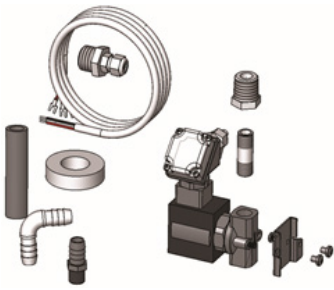

This chapter provides a list of replacement parts and support items for the 9220 Online TOC Analyzer. An asterisk (*) indicates replacement parts that are considered expendable (XPN). Maintaining a supply of expendable in stock is recommended.

Chassis Components		
Part Number	Description	Unit
332504	ASSY-COVER 9220 W/YSI LOGO	EA
860240	ASSY-COVER 9220 W/WTW LOGO	EA

Table 9.1 Chassis Components

Electronic Components		
Part Number	Description	Unit
332554	KIT-HMI LCD COMPUTER MODULE 9220	EA
332746	ASSY-POWER SUPPLY 9220	EA
333245	PCF-MAIN PIC 9220	EA
326645	DETECTOR-MODULE 9220 LINEARIZED	EA

Table 9.2 Electronic Components

Fluidic Components		
Part Number	Description	Unit
332557	ASSY-EPC MANIFOLD 9220	EA
333122	ASSY - SYRINGE DRIVE MODULE 9220	EA
327452	KIT - 9220 SYRINGE PLUNGER W/GLASS	EA
332524	ASSY-TC REACTOR MODULE 9220	EA
332571	ASSY-TC HEATER MODULE 9220	EA
332621	ASSY-6-PORT VALVE W/TUBING 9220	EA
326658	KIT-6-PORT VALVE TUBING 9220	EA
332578	ASSY-TEC CONDENSER 9220	EA
332392	ASSY-TRAP GLASS CONDENSER 9220	EA
332556	ASSY-PUMP PERSULFATE W/CHKVLV 9220	EA
332573	ASSY-DRAIN VALVE 9220	EA
333212	KIT-STARTUP 9220	EA
329689	KIT- REAGENT CONATINERS & TUBING 9220	EA

Table 9.3 Fluidic Components

327741 - KIT-ANNUAL MAINT 9220		
Part Number	Description	Unit
327740	KIT-TUBING ANNUAL MAINT 9220	EA
323607	VALVE-CHECK DUCKBILL EPDM	EA

Table 9.4 Kit-Annual Maint 9220 Components

327607 - KIT-TEC HEATSINK FAN 9220		
Part Number	Description	Unit
326663	FAN ASSY-24VDC 9220	EA

Table 9.5 Kit-TEC Heatsink Fan 9220 Components

327463 - 9220 PROCESS GAS MODULE (PGM)		
Part Number	Description	Unit
327301	KIT-PGM ACCUMULATOR 9220	EA
327303	KIT-PGM PUMP 9220	EA
327308	KIT-CO2 SCRUBBER 1KG 9220	EA
327900	KIT-ZERO AIR FILTER ASSY	EA
326833	FILTER-HOUSING 10" CLEAR BOWL	EA
326841	WRENCH-FILTER CANISTER PENTEK	EA
327783	FILTER-ELEMENT 10" REUSABLE (3PK)	PK
327785	TUBING-URTH 1/4Z1/8"ID CLEAR, 12" (3PK)	PK
FS-0005-04	PARTICULATE FILTER PROMO (4PK)	EA
326030	KIT-ZERO FILTER REPLACEMENT	EA

Table 9.6 9220 Process Gas Module (PGM) Components

327114 - KIT SAMPLE INLET SYSTEM 9220		
Part Number	Description	Unit
326462	FTNG-PP 1/2MNPT X 1/2"BARB (3PK)	PK
327781	VALVE-CHECK 1/4MNPTX3/16BARB 1/2 PSI (3PK)	PK

Table 9.7 Kit-Sample Inlet System 9220 Components

326389 - KIT-BR EXT SAMPLE VALVE 9220		
Part Number	Description	Unit
326387	VALVE-BR SOL 2WAY 1/4NPT 24V	EA
326383	FTNG-BR 1/4" PIPE NIPPLE X 1.5"	EA
327739	FTNG-BR 1/4" NPT X 1/2"HB	EA
326453	FTNG-ADAPT BR 1/2MNPTX 1/4FNPT (3PK)	PK
327287	CABLE-ASSY 9220 EXT SMPL VLV 38"	EA
326459	FTNG-NYL BUSH 1/2M TO 1/4"F NPT (3PK)	PK
326461	FTNG-PP 1/2" ELBOW HB (3PK)	PK

Table 9.8 Kit-BR Ext Sample Valve 9220 Components

326814 - KIT-SS EXT SAMPLE VLV 9220		
Part Number	Description	Unit
326811	VALVE-SS SOL 2WAY 1/4NPT 24V	EA
326813	FTNG-SS 1/4" PIPE NIPPLE X 1.5"	EA
327379	FTNG-SS 1/4" NPT X 1/2" HB	EA
326812	FTNG-ADAPT SS 1/2 MNPTX1/4FNPT	EA
327287	CABLE-ASSY 9220 EXT SMPL VLV 38"	EA
326459	FTNG-NYL BUSH 1/2M TO 1/4"F NPT (3PK)	PK
326461	FTNG-PP 1/2" ELBOW HB (3PK)	PK

Table 9.9 Kit-SS Ext Sample VLV 9220 Components

10. Method Development



The goal of method development is to achieve the highest possible TOC recovery from the sample. Selecting the proper mode is the first step in developing a sound method, but many other variables can significantly affect sample recovery, both programmable and non-programmable. Non-programmable factors include NDIR offset, room temperature, and humidity, along with reagent, gas, and sample purity. The programmable factors, which control the analytical operation, are summarized in Table 10.1.

10.1 Method Development Variables

Variable	Controlled By	Effect	Where Set
Carrier Gas Flow Rate	Electronic Pressure Controller (EPC)	Determines gas dilution effect of the CO ₂ generated in the TC Reactor, as it is carried to the NDIR detector of analysis	System Default
Sample Size	Syringe	Provides carbon mass to generate CO ₂	Config-Method
React Times	9220 Software	Adjusting the react times allows for more (or less) CO ₂ production prior to detect	Config-Method
Detect Times	9220 Software	Adjusting the Detect Times allows for more (or less) maximum detect time in which the sample peak can be completed	Config-Method
TIC Removal Time	9220 Software	Allows time for complete TIC Removal	Config-Method
Acid Volume	Syringe	Removes TIC-related CO ₂ from the sample, prior to analyzing for TOC	Config-Method
Acid Chase Volume	Syringe	Reduces carryover between samples by flushing the liquid lines with acid	Config-Method
Persulfate Volume	Persulfate Pump	Provides oxidant to release the TOC-related CO ₂ from the sample	Config-Method
Cal Low / Cal High	9220 Software	Determines the range of expected sample analysis; smaller ranges can improve accuracy	Config-Method
Standby Temperature	TC Reactor Heater	Optimal TOC oxidation heating is 98 °C	Config-System Config
Sample Prime Volume / # Primes	Syringe	Reduces sample-to-sample carryover	Config-Sample Intro
Replicate Prime Volume / # Primes	Syringe	Improves consistency of replicate analysis	Config-Sample Intro
Reagent Prime Volume/ # Primes	Syringe	Ensures the reagents are properly primed prior to starting an analysis sequence	Config-Sample Intro
Sample Loop Flush Time	9220 Software / Sample Loop	Ensures that a representative sample is in the loop for analysis by the 9220	Config-Sample Intro
Sample Loop Settling Time	9220 Software / Sample Loop	Allows undesirable particulates in the sample to settle out in the loop prior to analysis by the 9220	Config-Sample Intro

Table 10.1 Method Development Variables

Carrier Gas Flow Rate

Carrier Gas Flow Rate is determined by the automatic control of the internal Electronics Pressure Controller (EPC), in conjunction with the frit for the Carrier Gas in the Valve Manifold. Generally, the lower the flow rate, the higher the sensitivity for smaller CO₂ concentrations, and vice versa. The default carrier gas flow rate is 65 mL/min. The default internal regulator pressure is 13psi.

Sample Size

Sample Size is the single most significant, and easiest, parameter to change to affect the performance of the 9220 analyzer. Increasing sample size will provide more total carbon mass to be analyzed. This can be particularly beneficial in lower-concentration samples (i.e., less than 0.500ppm). However, increasing the sample size will also reduce the maximum sample concentration that can be detected, without having to dilute the sample, as the carbon mass can eventually exceed the maximum range of the NDIR detector (up to 250µg Carbon). Also, larger sample volumes can have the effect of reducing carryover between samples, due to simple volumetric dilution of residual sample in the internal flow path.

Decreasing the sample size can allow the 9220 analyzer to measure even higher concentration samples but may have the effect of reducing accuracy for lower concentration samples. Likewise, smaller sample volumes can have the effect of increasing potential carryover between samples, due to reduced volumetric dilution of residual sample in the internal flow path.

The default sample size for the 9220 is 2.0mL. Sample size can be adjusted from 0.5mL up to 10.0mL. However, this volume must also take the Acid Volume and Persulfate Volume into consideration, such that the total volume does not exceed 10.0mL.

React Times

Reaction Time parameters can significantly change sample recovery. If recovery is dramatically less than expected or a peak looks truncated, then the react times may require adjusting. The react time is the time between when reagent addition to the sample occurs, and when the sample is purged and sent to the NDIR detector. If the sample has a high concentration or is slow to react, not all of the carbon may have enough time to convert to CO₂ before the sample is purged.

Detect Times

The Detect Time is the maximum length of time that the line from the reaction chamber is placed in line with the NDIR detector. If the sample is highly concentrated, the unit may not have enough time to cycle all the CO₂ through the NDIR detector, and the detect time needs to be lengthened.

TIC Removal Time

When running NPOC-Only analysis, the TIC-related CO₂ contribution is considered unimportant and must be removed from the sample prior to TOC analysis. To completely remove the TIC-related CO₂, acid must be added to the sample, and then the sample must be sparged for a sufficient time to allow the CO₂ to be removed.

Laboratory tests can be used to determine the minimum TIC removal time required to remove the maximum amount of TIC expected in the sample stream to be analyzed.

NOTE: If the TIC Removal Time, or Acid Volume, is insufficient in removing the TIC-related CO₂ from the sample, the TOC analysis can be adversely affected by the residual CO₂ from the TIC. This can be particularly significant in samples with high TIC concentrations and low TOC concentrations.

Acid Volume

The Acid Volume is used to facilitate the release of TIC-related CO₂ from the sample. Typically, this is done as TIC removal during the NPOC-Only analysis mode, where the TIC contribution in the sample is not important for analysis.

Typically, a solution of 5% Phosphoric Acid is used in the 9220 analyzer. The volume of acid specified must be sufficient to reduce the pH of the sample to 2 or lower, to completely convert and release the TIC-related CO₂ from the sample. Simple lab tests using pH paper can be performed to determine the amount of acid required to reduce the pH to 2 or less, given the amount of sample specified for analysis in the 9220.

NOTE: *If the TIC Removal Time, or Acid Volume, is insufficient in removing the TIC-related CO₂ from the sample, the TOC analysis can be adversely affected by the residual CO₂ from the TIC. This can be particularly significant in samples with high TIC concentrations and low TOC concentrations.*

Acid Chase Volume

The **Acid Chase** is a volume of acid that is drawn into the syringe, after the sample has been transferred to the TOC Reactor to collect any remaining sample droplets and sweep them into the reactor as well. While this feature does consume additional acid reagent, it can increase sample accuracy and dramatically reduce sample-to-sample carryover by ensuring that residual sample in the liquid lines is flushed into the reactor.

Persulfate Volume

The **Persulfate Volume** is used to specify the amount of oxidant to inject to perform the TOC-related oxidation step during the TOC React and TOC Detect states. Once the sample (and acid) is transferred from the syringe into the TOC Reactor, the persulfate is injected into the reactor to start the oxidation process.

Depending on the TOC concentration of the sample, the persulfate volume will need to be adjusted to ensure that complete oxidation is achieved. The persulfate volume specified should be a slight stoichiometric excess of what is required, to ensure that there is always enough oxidant to oxidize the sample.

However, excessive amounts of persulfate can be undesirable, since this will result in an unnecessary increase in reagent consumption and can lead to errors in lower concentration samples due to the small TOC "background" from the persulfate itself.

Cal Low/Cal High

The **Calibration Low (Cal Low)** and **Calibration High (Cal High)** values are used to determine the calibration range of the 9220 analyzer. These values should be set to properly "bracket" the sample concentration range that is expected. Typically, the smaller the calibration range specified, the better the accuracy of the sample results.

Also, it is important to note that if a sample were to exceed the calibration range, the 9220 will still calculate a result for that sample. So, it is recommended that the calibration range be specified to include the nominal sample concentrations, up to a practical "cut off" TOC concentration level, beyond which the 9220 would only be used to give an indication of how high the concentration has exceeded the range.

Standby Temperature/Offset Temperature

The 9220 analyzer runs in an "isothermal" condition, where the TOC Reactor is maintained at a constant set-point throughout the entire analysis sequence. Optimal TOC oxidation heating is 98 °C, which is set in the **Standby Temperature**.

The Standby Temperature may require a slight adjustment to account for changes in heating due to elevated altitudes. Otherwise, these temperatures should not be adjusted, as lower temperatures can adversely affect TOC oxidation performance.

Sample Prime Volume/# Primes

The **Sample Prime Volume** is the most important prime volume specified in the 9220 analyzer. This priming feature, when specified properly, can dramatically reduce sample-to-sample carryover. The default sample prime volume is 5mL, and the default # of primes is 2.

The Sample Prime volume must be set to guarantee that a fresh, representative sample is drawn from the sample source (i.e., sample loop or another container). Typically, 5mL with two primes is acceptable for the default lengths of tubing provided with the 9220. If the sample inlet tubing lengths are changed, this prime volume should be adjusted accordingly.

Due to nominal dilution effects, using multiple primes of a smaller volume shows a better reduction in carryover than using a single prime of a larger volume. For example, using two primes of 5mL of sample is much better at reducing sample-to-sample carryover than using one prime of 10mL.

Sample Prime is particularly critical for the 6-port sampler system to analyze multiple streams with varying TOC concentrations. While all streams must be properly bracketed by the 9220's calibration range, a proper Sample Prime will help ensure that samples on the extremes of the calibration range do not interfere with each other.

NOTE: *The Sample Loop Flush Time is also important in this multi-stream configuration.*

Sample Prime is only performed prior to the first replicate of a sample. For each successive replicate, the Replicate Prime volume is used.

Replicate Prime Volume/# Primes

The **Replicate Prime Volume** is used to ensure that successive replicates of a sample are all properly primed for improved precision of the measurements. Typically, replicates are not used for "real" process samples, as the sample is likely always changing as a function of the process that it is monitoring. However, replicates can be useful for analysis of calibration and validation standards to determine system precision.

To conserve sample, the Replicate Prime can be set to a much smaller volume (e.g., 0.5mL) than the Sample Prime, since it can be assumed that the representative sample is already in the sample tubing going into the 9220 analyzer. If this is not the case, the replicate prime volume should be increased as needed.

Reagent Prime Volume/# Primes

The **Reagent Prime Volume** is used to specify the volume of reagent to be primed to ensure that fresh reagent is drawn up to the point of use within the 9220 analyzer. The reagent prime is only performed at the start of a sequence, not prior to every sample. It is important that fresh reagent be available in the reagent containers prior to the start of a sequence. Be sure to confirm that the reagent lines are filled to their point of use, with no air bubbles, after the Reagent Prime has been completed when first starting a sequence.

NOTE: *The default Reagent Prime volume is not sufficient to prime the persulfate line completely when those lines are empty, due to the internal volume of the persulfate pump, check valve, and tubing. Be sure to perform one or more manual reagent prime steps from the Maint → Manual Controls screen, until the persulfate lines are completely full with no air bubbles up to the TOC Reactor.*

Sample Loop Flush Time

When analyzing a process sample, it is important to get a representative (i.e., "fresh") sample into the sample loop prior to the 9220 drawing in the sample. A proper sample flush time, which ensures that a representative sample is in the loop, must take into account several factors, including sample flow rate, distance/time the sample has to travel to reach the sample inlet loop, volume of the sample inlet loop, and overflow/ dilution required to ensure that the sample represents the process stream.

If the sample flow rate, or pressure, in the "fast loop" that is being used to supply sample to the 9220's sample inlet loop is too high, a manual valve may be required to restrict the flow rate, or pressure, to an acceptable level.

Sample Loop Settling Time

Often, process samples contain particulate that may, or may not be, desired for analysis by the 9220 for its TOC contribution. If the particulate size meets the 9220 specification, and it is desirable to analyze the particulate as part of the TOC contribution, then set the **Sample Loop Settling Time** to 0 seconds, so that no settling is required.

However, if particulates in the sample are not to be analyzed for their TOC contribution, setting the proper settling flush time ensures that any undesirable particulates in the sample have no time to settle out in the loop prior to analysis by the 9220. Monitor the behavior of the process sample in the loop and adjust the settling time as needed.

10.2 Method Verification Techniques

Several different ways can be used to ensure a method detects all the carbon in a sample. Use verification techniques whenever a large increase in concentration is expected, or a new method is created for a sample in an unknown range. The following include helpful hints for testing a method.

Serial Dilution

Serial Dilution tests if the sample is too concentrated for the NDIR detector to handle the amount of carbon extracted. Dilute the sample on a set ratio and check that the unit returns a linear response. If the response curve is flat for the first few sample dilutions and then begins to curve downward, the sample is too concentrated. Dilute the sample and try again.

Matrix Spike Recovery

The **Matrix Spike Recovery** test determines if the unit's measurements are accurate. First run the sample and record the results. Then, add a known standard to the sample and run the sample again. The response should be equal to the concentration of the sample plus the addition of the standard. If this is not the case, the method may not be detecting all of the carbon, or the unit needs a better calibration.

11. System Calculations

11.1 Instrument Calibration: Linear Regression

A Linear Regression is used to establish calibration curves for analytical analysis. The curve establishes a mathematical relationship between the instrumental response and the amount or concentration of the sample analyzed. A number of factors need consideration when establishing this curve with the accuracy of the original standards used for the analysis is perhaps most important. Mathematical considerations must also be examined to properly use a calibration curve for analysis of unknown samples.

For the best accuracy, use short calibration ranges if possible (best across one to two orders of magnitude). Measurement accuracy improves greatly if samples are requalified into high, low, and mid ranges. If the samples are truly unknown, then perform a qualification run to determine the range to run the instrument. Although most instruments can be calibrated across their entire dynamic range, avoid using the entire range since linearity suffers, and overall accuracy is sacrificed for all samples. Shorter calibration ranges allow the user to optimize instrument conditions for each range in question.

11.2 9220 Calibration Calculations

The 9220 calculates the calibration curve using a weighted linear regression.

Calibration Curve Definitions

Table 11.1 lists the terms and their definitions used in calculating a calibration curve.

Term	Definition
Area (obs)	Area obtained by integration of the linearized NDIR detector response for a specific standard
Area (std)	Contribution to the observed area due to the carbon in the calibration standard
Area (rw)	Contribution to the observed area due to the carbon in the Reagent Blank water
Mass (inj)	The total mass of carbon in a calibration standard
Mass (std)	The mass of carbon quantitatively added into the calibration standard
Mass (rw)	The mass of carbon inherently present in a Reagent Blank water

Table 11.1 Calibration Curve Terms and Definitions

Further, the following equations apply, where y_0 is the $Area_{offset}$:

- $Area (obs) = Area (std) + Area (rb)$
- $Mass (inj) = Mass (std) + Mass (rb)$

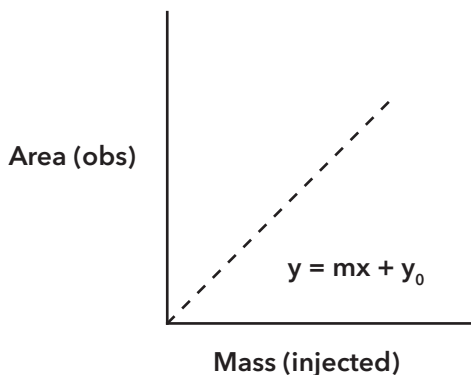

Standard Deviation and Relative Standard Deviation

Terms

- n = number of non-outlier replicates in the sample
- x_i = i^{th} replicate of n replicates at specific level (or i^{th} aliquot from same sample)
- \bar{x} = mean of samples
- SD = standard deviation
- RSD = relative standard deviation

Standard Deviation

$$SD = \sqrt{\frac{n \times \sum x_i^2 - (\sum x_i)^2}{n \times (n - 1)}}$$

Relative Standard Deviation

$$RSD = 100 \times n \times \frac{SD}{\sum x_i}$$

Calibration Calculation

Terms

- Volume (V) = sample volume
- Weight (w_{ij}) = $1/\text{Concentration of Cal-High}$ [same for all replicates]
- mass (c_{ij}) = Concentration of i^{th} replicate of j^{th} standard
- area (a_{ij}) = Area (obs) for i^{th} replicate of j^{th} standard
- $S_w = \sum w_{ij}$
- $S_x = \sum (w_{ij} \times c_{ij})$, $i = 1, 2, \dots, n$; $j = 1, 2$
- $S_y = \sum (w_{ij} \times a_{ij})$, $i = 1, 2, \dots, n$; $j = 1, 2$
- $S_{xy} = \sum (w_{ij} \times c_{ij} \times a_{ij})$
- $S_{xx} = \sum (w_{ij} \times c_{ij}^2)$

RF = Relative Response Factor

$$\text{Slope (m)} = \frac{S_w \times S_{xy} - S_x \times S_y}{S_w \times S_{xx} - S_x^2}$$

$$RF = \frac{V}{m}$$

R² = Goodness of Fit of the Calibration

$$Y_{avg} = \frac{S_y}{S_w}$$

$$\text{Error1 } (e_{1ij}) = (a_{ij} - m \times x_{ij} - y_0)$$

$$\text{Error2 } (e_{2ij}) = (a_{ij} - Y_{avg})$$

$$R_2 = \left(1 - \frac{\sum w_{ij} \times e_{1ij}^2}{\sum w_{ij} \times e_{2ij}^2} \right)$$

Area_{Offset} = Offset of the calibration curve, in Area Counts

$$\text{Area}_{\text{Offset}}(y_0) = \left(\frac{S_y - m_w \times S_x}{S_w} \right)$$

Mass_{Offset} = Offset of the calibration, in µgC

$$\text{Mass}_{\text{Offset}} = -1 \times y_0 \times RF$$

Sample Calculations

Unknown samples are calculated by first finding the Mass of the sample. To do so, the Area Counts related to the Offset value (specified in the Calibration screen) must be subtracted. This accounts for both the Reagent Blank and any instrumental factors.

$$\text{Mass}_{\text{sample}} = (\text{Area}_{\text{Peak}} - \text{Area}_{\text{Offset}}) \cdot (RF \div 1000)$$

To find the Concentration of the unknown sample, the Mass of the sample must be divided by the Sample Volume specified in the Method settings.

$$\text{Concentration}_{\text{sample}} = \text{Mass}_{\text{sample}} / \text{Sample Volume}$$

$$\text{Concentration}_{\text{sample_final}} = M \times \text{Concentration}_{\text{sample}}^C$$

Validation Standard Calculations

Validation standards are calculated by again finding the Mass of the standard. To do so, the Offset of the calibration curve (in Area Counts) must be subtracted. This accounts for both the Reagent Blank value as well as the water into which the Validation Standard was made. For best accuracy, the Validation Standard should be made with the same water as the original Calibration Standards.

$$\text{Mass}_{\text{sample}} = (\text{Area}_{\text{Peak}} - \text{Area}_{\text{Offset}}) \cdot (RF \div 1000)$$

To find the Concentration of the Validation Standard, the Mass of the standard must be divided by the Sample Volume specified in the Method settings.

$$\text{Concentration}_{\text{standard}} = \text{Mass}_{\text{standard}} / \text{Sample Volume}$$

Appendix A - Reagent Preparation



Phosphoric Acid Reagent Preparation

Purpose

This procedure describes preparation of the 5% phosphoric acid reagent for the 9220 TOC.

WARNING: *Phosphoric acid is corrosive and harmful, and appropriate precautions should be observed when handling it. Mixing acid with water causes a highly exothermic reaction. Appropriate precautions should be observed when mixing chemicals.*

Materials

- ACS reagent grade, 85% phosphoric acid (H_3PO_4) (part number 110-080 for 85% acid)
- Reagent water
- 1-L volumetric flask
- 100-mL graduated cylinder

Procedure

1. Prepare a 5% H_3PO_4 solution by adding 59.0 mL of 85% H_3PO_4 to reagent water for a total volume of 1,000 mL.
2. Transfer the solution to the acid reagent bottle provided with the 9220 TOC.
3. Purge the reagent for several minutes after connecting to the instrument.

NOTE: *If high organic contamination of the solution is suspected, purify the acid by adding 10 cc of persulfate solution and immerse the vented container in boiling water for at least two hours. Purge the cooled solution for several minutes to remove any CO_2 from oxidation of organics. This process greatly decreases the reagent blank, and thus, is not generally worth the purification effort unless the acid solution is abnormally high in TOC.*

Sodium Persulfate Reagent Preparation

Purpose

This procedure describes preparation of the 100g/L (10%) sodium persulfate reagent for the 9220 TOC.

WARNING: *Sodium persulfate ($\text{Na}_2\text{S}_2\text{O}_8$) is a strong oxidizer, and appropriate precautions should be observed when handling it.*

Materials

- Sodium persulfate ($\text{Na}_2\text{S}_2\text{O}_8$) (part number 174194 for 100 g of crystals; part number 178848 for 500 g of crystals)
- Reagent water
- 1-L volumetric flask
- Analytical balance

Procedure

1. Prepare a 100 g/L (10%) sodium persulfate solution by adding 100 g of $\text{Na}_2\text{S}_2\text{O}_8$ to water to create a total volume of 1,000 mL. Stirring may be necessary, but do not heat.
2. Transfer the solution to the reagent bottle supplied with the 9220 TOC. Do not tighten the lid.
3. Purge with gas for several minutes after connecting the bottle to the instrument.
4. Shelf life is approximately three weeks. Refrigerated shelf life is approximately eight weeks.

NOTE: *A 200-g/L solution may be used for a carbon mass of 50 μg or more.*

Declaration of Conformity



The undersigned hereby declares that the products listed below conform to all applicable Essential Requirements of the listed Directives and Standards and carry the CE mark accordingly.

Manufacturer's Name	YSI, a Xylem brand
Manufacturer's Address	1725 Brannum Lane Yellow Springs, OH 45387 USA
Product Name	MODEL9220 - YSI PROCESS TOC ANALYZER
Item Number	333205

Directives:

- EMC 2014/30/EU
- LVD 2014/35/EU
- WEEE 2012/19/EU
- RoHS 2011/65/EU

Harmonized Standards:

- EN 61326-1:2013, Electrical equipment for measurement, control and laboratory use - EMC requirements - Part 1: General requirements
- EN 61326-2-3:2013, Electrical equipment for measurement, control and laboratory use - EMC requirements - Part 2-3: Particular requirements - Test configuration, operational conditions and performance criteria for transducers with integrated or remote signal conditioning
- EN 61000-3-2:2014, Electromagnetic compatibility (EMC) - Part 3-2: Limits - Limits for harmonic current emissions (equipment input current ≤ 16 A per phase)
- EN 61000-3-3:2013, Electromagnetic compatibility (EMC) - Part 3-3: Limits - Limitation of voltage changes, voltage fluctuations and flicker in public low-voltage supply systems, for equipment with rated current ≤ 16 A per phase and not subject to conditional connection
- EN 55011:2009/A1:2010, Industrial, scientific and medical equipment - Radio-frequency disturbance characteristics - Limits and methods of measurement.
- EN 61010-1-1:2010/A1:2019 - Safety requirements for electrical equipment for measurement, control and laboratory use - Part 1: General requirements

A handwritten signature in black ink that reads "Gregory W. Popp". The signature is written in a cursive style.

Gregory Popp
Quality Manger

12 July 2024

Xylem |'zīləm|



- 1) The tissue in plants that brings water upward from the roots;
- 2) a leading global water technology company.

We're a global team unified in a common purpose: creating advanced technology solutions to the world's water challenges. Developing new technologies that will improve the way water is used, conserved, and re-used in the future is central to our work. Our products and services move, treat, analyze, monitor and return water to the environment, in public utility, industrial, residential and commercial building services settings. Xylem also provides a leading portfolio of smart metering, network technologies and advanced analytics solutions for water, electric and gas utilities. In more than 150 countries, we have strong, long-standing relationships with customers who know us for our powerful combination of leading product brands and applications expertise with a strong focus on developing comprehensive, sustainable solutions.

For more information on how Xylem can help you, go to www.xylem.com



YSI, a Xylem brand
1725 Brannum Lane
Yellow Springs, OH 45387

- +1.937.767.7241
- info@ysi.com
- ysi.com

© 2024 Xylem Inc. 333321 0824



ysi.com/9220